



LIFTING CHARTS - All Terrain Cranes

LIEBHERR MODEL LTM 1160-5.2 - 190 TON CAPACITY

Boom/jib combinations Configurations de flèche

- T** Telescopic boom/Flèche télescopique
- K** Assembly jib/Flechette de montage
- NZK** Hydraulic swing away jib/Fléchette pliante hydraulique
- V** Telescopic boom extension/Rallonge de flèche télescopique





LIFTING CHARTS - All Terrain Cranes

LIEBHERR MODEL LTM 1160-5.2 - 190 TON CAPACITY

Lifting capacities Forces de levage

T

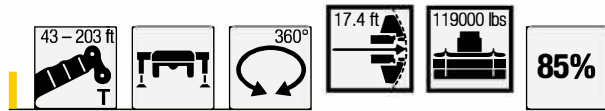

Jib Length (ft)	Lifting Capacity (Tons)													Jib Length (ft)
	43 ft	57 ft	72 ft	87 ft	102 ft	116 ft	131 ft	146 ft	161 ft	176 ft	191 ft	203 ft		
10	352.7	189.6	189.6	189.6										10
11	313.1	189.6	189.6	189.6	189.6									11
12	300.9	189.6	189.6	189.6	189.6									12
13	289.8	189.6	189.6	189.6	189.6									13
14	279.3	189.6	189.6	189.6	189.6									14
15	268.7	189.6	189.6	189.6	189.6	166.6								15
16	256.8	189.6	189.6	189.6	189.6	165.4								16
17	242.6	189.6	189.6	189.6	189.6	164.2								17
18	229.5	189.6	189.6	189.6	189.6	163	131.3							18
19	217.5	189.6	189.5	189.6	189.3	161.8	130							19
20	206.6	188.4	186.8	188.5	188.6	160.6	128.7							20
22	187.7	175.9	176.7	176.3	175.4	158.1	126.1	94.6						22
24	171.9	164	165.3	164.8	165.3	155.2	123.5	91.3	74.7					24
26	158.3	152.8	154.5	155	154.3	151.3	120.9	88	73.3					26
28	146.5	142.7	144.5	145	144.4	143.3	118.4	84.7	71.4	59.3				28
30	136.2	133.7	135.5	136	135.2	134.3	115.9	81.6	69.4	58.2				30
32	127.2	125.1	127	127.5	126.8	125.8	113.5	78.9	67.5	56.9	48.8			32
34	119.2	116.5	118.5	119.2	118.6	117.5	111	76.4	65.5	55.7	47.9			34
36	106.3	106.2	110.9	111.5	110.9	109.7	108.5	73.9	63.6	54.4	47	37.7		36
38			104	104.6	103.9	104.6	104.5	71.4	61.8	53.2	46.1	37.3	30.3	38
40			97.9	98.4	97.8	99.5	98.4	69.1	60.1	51.9	45.2	36.7	30	40
45			83.9	84.5	85.9	85.6	84.3	63.9	55.6	48.6	43	35.4	29	45
50			72.9	73.4	75.3	74.6	73.4	58.9	52	45.3	41	34.2	28	50
55				64.6	66.4	65.6	64.3	54.7	48.5	42.6	39.2	32.9	26.9	55
60				59	59.1	58.3	57	50.7	45.3	40	37.3	31.5	25.8	60
65				52.9	52.8	52	50.7	47.5	42.5	37.6	35.3	30.3	24.8	65
70					47.5	46.6	45.3	44.5	39.7	35.5	33.4	29	23.8	70
75					42.9	42	40.7	41.6	37.3	33.4	31.6	27.8	22.7	75
80					38.9	38.2	36.8	37.6	35.1	31.5	29.9	26.6	21.7	80
85						35.7	34.8	34.2	32.8	29.7	28.3	25.4	20.7	85
90						32.8	33	31.2	30.8	28.1	26.8	24.3	19.6	90
95						28.7	30.3	28.5	28.6	26.6	25.4	23.2	18.6	95
100							28	26.1	26.2	25.1	24	22.1	17.7	100
105							25.9	24.5	24.1	23.1	22.8	21	16.7	105
110							20.7	23.5	22.2	21.9	21.3	20	15.9	110
115								22.2	20.4	20.6	19.6	19.1	15	115
120								20.6	18.9	19	18.8	18.2	14.2	120
125								14.2	17.6	17.6	17.9	17.2	13.5	125
130									17	16.3	16.7	15.8	12.8	130
135									16.5	15	15.5	14.6	12.1	135
140										13.9	14.3	13.5	11.6	140
145										13.3	13.3	12.4	11.1	145
150										12.8	12.4	11.6	10.6	150
155											11.6	10.8	10.1	155
160											10.9	10.1	9.7	160
165											10.3	9.4	9.3	165
170												8.8	8.8	170
175												8.2	8.2	175
180												7.7	7.7	180
185													7.1	185
190													6.7	190
195													6.2	195

* ± 0° over rear - en arrière



LIFTING CHARTS - All Terrain Cranes

LIEBHERR MODEL LTM 1160-5.2 - 190 TON CAPACITY

Lifting capacities Forces de levage

T



	43 ft	57 ft	72 ft	87 ft	102 ft	116 ft	131 ft	146 ft	161 ft	176 ft	191 ft	203 ft	
10	189.6	189.6	189.6										10
11	189.6	189.6	189.6	189.6									11
12	189.6	189.6	189.6	189.6									12
13	189.6	189.6	189.6	189.6									13
14	189.6	189.6	189.6	189.6									14
15	189.6	189.6	189.6	189.6	166.6								15
16	189.6	189.6	189.6	189.6	165.4								16
17	189.6	189.6	189.6	189.6	164.2								17
18	189.6	189.6	189.6	189.6	163	131.3							18
19	189.6	189.6	189.6	189.6	161.8	130							19
20	189.6	189.6	189.6	189.6	160.6	128.7							20
22	186.9	185.8	187.3	182.7	158.1	126.1	94.6						22
24	171.9	172.7	172.6	171.8	155.2	123.5	91.3	74.7					24
26	158.3	160.1	160.5	160	152.3	120.9	88	73.3					26
28	146.5	148.4	149	148.5	146.7	118.4	84.7	71.4	59.3				28
30	136.2	138.1	138.7	137.9	136.9	115.9	81.6	69.4	58.2				30
32	127.2	129	129.6	129	127.8	113.5	78.9	67.5	56.9	48.8			32
34	119.2	121	121.5	121	120.1	111	76.4	65.5	55.7	47.9			34
36	106.3	113.8	114.3	113.8	112.8	108.5	73.9	63.6	54.4	47	37.7		36
38		107.3	107.9	107.2	106.3	105.4	71.4	61.8	53.2	46.1	37.3	30.3	38
40		101.6	102	101.5	101.4	101.2	69.1	60.1	51.9	45.2	36.7	30	40
45		89.2	89.6	89.1	90.5	89.4	63.9	55.6	48.6	43	35.4	29	45
50		77.5	79.7	79.5	80.6	79.1	58.9	52	45.3	41	34.2	28	50
55			69.5	71.5	70.7	69.3	54.7	48.5	42.6	39.2	32.9	26.9	55
60			61	62.9	62.1	60.8	50.7	45.3	40	37.3	31.5	25.8	60
65			54.7	55.9	55.1	53.8	47.5	42.5	37.6	35.3	30.3	24.8	65
70				50.2	49.3	48.1	44.5	39.7	35.5	33.4	29	23.8	70
75				45.4	44.5	43.2	42.1	37.3	33.4	31.6	27.8	22.7	75
80				38.9	40.4	39.1	39.6	35.1	31.5	29.9	26.6	21.7	80
85					36.9	35.5	36.3	33.1	29.7	28.3	25.4	20.7	85
90					34	33.2	33.2	31.2	28.1	26.8	24.3	19.6	90
95					28.7	31.7	30.5	29.3	26.6	25.4	23.2	18.6	95
100						29.9	28	27.9	25.1	24	22.1	17.7	100
105						27.7	25.9	26	23.8	22.8	21	16.7	105
110						20.7	24	24.1	22.6	21.7	20	15.9	110
115							22.6	22.3	21.3	20.6	19.1	15	115
120							21.8	20.8	20	19.6	18.2	14.2	120
125							14.2	19.3	19.1	18.3	17.3	13.5	125
130								17.9	18.1	17.2	16.6	12.8	130
135								16.7	16.8	16.5	15.8	12.1	135
140									15.6	15.8	15	11.6	140
145									14.5	15	14	11.1	145
150									13.5	14	12.9	10.6	150
155										13	12	10.1	155
160										12.2	11.1	9.7	160
165										11.4	10.3	9.3	165
170											9.5	8.9	170
175											8.8	8.5	175
180											8.2	8.1	180
185												7.5	185
190												6.9	190
195												6.3	195



LIFTING CHARTS - All Terrain Cranes

LIEBHERR MODEL LTM 1160-5.2 - 190 TON CAPACITY

Lifting capacities Forces de levage

T

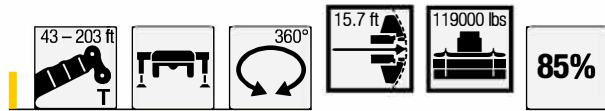

Jib Length (ft)	Lifting Capacity (Tons)													Jib Length (ft)
	43 ft	57 ft	72 ft	87 ft	102 ft	116 ft	131 ft	146 ft	161 ft	176 ft	191 ft	203 ft		
10	352.7	189.6	189.6	189.6										10
11	307.6	189.6	189.6	189.6	189.6									11
12	295.6	189.6	189.6	189.6	189.6									12
13	284.6	189.6	189.6	189.6	189.6									13
14	274.3	189.6	189.6	189.6	189.6									14
15	263.3	189.6	189.6	189.6	189.6	166.6								15
16	249.2	189.6	189.6	189.6	189.6	165.4								16
17	235.2	189.6	189.6	189.6	189.6	164.2								17
18	222.5	189.6	189.6	189.6	189.6	163	131.3							18
19	210.9	188.3	189.3	188.5	187.8	161.8	130							19
20	200.3	184.4	183.9	184.8	183.6	160.6	128.7							20
22	181.9	171.1	171.9	171.5	172.3	158.1	126.1	94.6						22
24	166.5	159.3	161	161.1	160.8	155	123.5	91.3	74.7					24
26	153.3	148.2	149.9	150.5	149.7	148.8	120.9	88	73.3					26
28	141.9	138.4	140.1	140.7	140.1	139	118.4	84.7	71.4	59.3				28
30	131.9	129.6	131.4	131.8	131.1	130.2	115.9	81.6	69.4	58.2				30
32	123.2	120.5	122.5	123.2	122.4	121.2	113.5	78.9	67.5	56.9	48.8			32
34	115.4	112.1	114.1	114.8	114.2	113.1	110.9	76.4	65.5	55.7	47.9			34
36	106.1	104.8	106.7	107.3	106.7	107.9	106.9	73.9	63.6	54.4	47	37.7		36
38			100.1	100.7	100	101.6	100.5	71.4	61.8	53.2	46.1	37.3	30.3	38
40			93.9	94.6	94.5	95.6	94.4	69.1	60.1	51.9	45.2	36.7	30	40
45			80.3	80.9	82.8	81.9	80.7	63.9	55.6	48.6	43	35.4	29	45
50			70.7	70.2	72.1	71.3	70.1	58.9	52	45.3	41	34.2	28	50
55				63.5	63.5	62.7	61.4	54.7	48.5	42.6	39.2	32.9	26.9	55
60				56.4	56.4	55.6	54.3	50.7	45.3	40	37.3	31.5	25.8	60
65				50.4	50.3	49.4	48.1	47.5	42.5	37.6	35.3	30.3	24.8	65
70					45.1	44.3	43	43.8	39.7	35.5	33.4	29	23.8	70
75					40.8	40.6	39.1	39.4	37.3	33.4	31.6	27.8	22.7	75
80					37.1	37.1	36.7	35.6	34.4	31.5	29.9	26.6	21.7	80
85						33.9	34.1	32.3	32.2	29.7	28.3	25.4	20.7	85
90						31	31.2	29.4	29.5	28.1	26.8	24.3	19.6	90
95						28.7	28.7	27.2	27	25.9	25.4	23.2	18.6	95
100							26.4	25.7	24.7	24.1	23.8	22.1	17.7	100
105							24.4	24.3	22.6	22.8	21.7	21	16.7	105
110							20.7	22.5	20.8	21	20.6	20	15.9	110
115								20.8	19.3	19.3	19.5	18.9	15	115
120								19.8	18.3	17.7	18.2	17.3	14.2	120
125								14.2	17.6	16.3	16.8	15.9	13.5	125
130									17	15.1	15.5	14.6	12.8	130
135									15.9	14.4	14.3	13.4	12.1	135
140										13.8	13.2	12.4	11.6	140
145										13	12.3	11.5	11.1	145
150										12.1	11.5	10.7	10.6	150
155											10.8	10	10	155
160											10.1	9.3	9.3	160
165											9.5	8.6	8.6	165
170												8.1	8	170
175												7.5	7.5	175
180												7	6.9	180
185													6.4	185
190													6	190
195													5.6	195



LIFTING CHARTS - All Terrain Cranes

LIEBHERR MODEL LTM 1160-5.2 - 190 TON CAPACITY

Lifting capacities Forces de levage

T

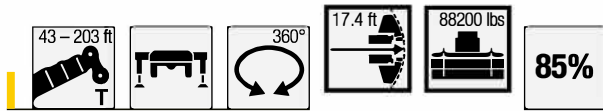

	43 ft	57 ft	72 ft	87 ft	102 ft	116 ft	131 ft	146 ft	161 ft	176 ft	191 ft	203 ft	
10	189.6	189.6	189.6										10
11	189.6	189.6	189.6	189.6									11
12	189.6	189.6	189.6	189.6									12
13	189.6	189.6	189.6	189.6									13
14	189.6	189.6	189.6	189.6									14
15	189.6	189.6	189.6	189.6	166.6								15
16	189.6	189.6	189.6	189.6	165.4								16
17	189.6	189.6	189.6	189.6	164.2								17
18	189.6	189.6	189.6	189.6	163	131.3							18
19	188.9	189.3	189	188.3	161.8	130							19
20	185.9	184.6	186.4	185.3	160.6	128.7							20
22	171.4	172.3	171.9	172.3	158.1	126.1	94.6						22
24	158.8	160.5	160.7	160.3	154.7	123.5	91.3	74.7					24
26	146.3	148.4	148.8	148.3	145.4	120.9	88	73.3					26
28	134.2	136.4	137.1	136.5	134.6	118.4	84.7	71.4	59.3				28
30	123.8	126	126.6	125.7	124.4	115.9	81.6	69.4	58.2				30
32	114	116.2	117	116.2	115.8	112.5	78.9	67.5	56.9	48.8			32
34	105	107.3	108	107.5	108.7	105.6	76.4	65.5	55.7	47.9			34
36	97.2	99.4	100.1	101.5	101.3	98.8	73.9	63.6	54.4	47	37.7		36
38		92.4	93.1	95	94.4	92.7	71.4	61.8	53.2	46.1	37.3	30.3	38
40		86.3	87	88.9	88.2	86.8	69.1	60.1	51.9	45.2	36.7	30	40
45		74.1	75.5	75.7	74.8	73.5	63.9	55.6	48.6	43	35.4	29	45
50			63.5	64.9	65	64.2	62.9	58.9	52	45.3	41	34.2	50
55				56.5	56.6	55.8	54.4	54.1	48.5	42.6	39.2	32.9	55
60				49.8	49.8	49	47.9	48.6	45.3	40	37.3	31.5	60
65				44.3	44.2	44.5	44.1	43	41.6	37.6	35.3	30.3	65
70					39.5	39.8	40.1	38.2	38.4	35.5	33.4	29	70
75					36.3	35.8	36.1	34.5	34.4	33	31.6	27.8	75
80				33	33.1	32.6	31.7	31	30	29.8	26.6	21.7	80
85					30.4	29.6	29.7	28	27.9	27.1	25.4	20.7	85
90					27.8	27	27	25.3	25.6	25	24.3	19.6	90
95					25.6	24.7	24.7	23.8	23.2	23.6	22.7	18.6	95
100						22.9	22.9	22	21.1	21.5	20.8	17.7	100
105						21.1	21.2	20.9	19.5	19.7	18.9	16.7	105
110						19.7	19.6	19.5	18.5	18	17.2	15.9	110
115							18.1	18	17.2	16.5	15.6	15	115
120							16.7	16.6	15.8	15.1	14.2	14.1	120
125							14.2	15.4	14.5	13.8	13	13	125
130								14.2	13.4	12.6	11.9	11.9	130
135								13.2	12.3	11.7	11	11	135
140									11.5	10.9	10.1	10.2	140
145									10.8	10.1	9.4	9.4	145
150									10.1	9.4	8.6	8.6	150
155										8.7	8	8	155
160										8.2	7.3	7.3	160
165										7.6	6.7	6.7	165
170											6.1	6.1	170
175											5.4	5.4	175
180											4.8	4.8	180
185												4.2	185
190												3.7	190



LIFTING CHARTS - All Terrain Cranes

LIEBHERR MODEL LTM 1160-5.2 - 190 TON CAPACITY

Lifting capacities Forces de levage

T

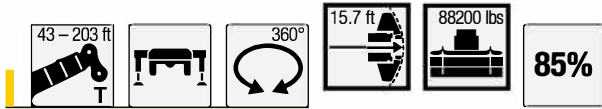

	43 ft	57 ft	72 ft	87 ft	102 ft	116 ft	131 ft	146 ft	161 ft	176 ft	191 ft	203 ft	
10	189.6	189.6	189.6										10
11	189.6	189.6	189.6	189.6									11
12	189.6	189.6	189.6	189.6									12
13	189.6	189.6	189.6	189.6									13
14	189.6	189.6	189.6	189.6									14
15	189.6	189.6	189.6	189.6	166.6								15
16	189.6	189.6	189.6	189.6	165.4								16
17	189.6	189.6	189.6	189.6	164.2								17
18	189.6	189.6	189.6	189.6	163	131.3							18
19	187.4	189.2	187.6	187	161.8	130							19
20	181.6	182	182.1	180.9	160.6	128.7							20
22	167.2	168.1	168.7	168.8	158.1	126.1	94.6						22
24	154.8	156.6	157.1	156.4	152.7	123.5	91.3	74.7					24
26	141.7	143.8	144.5	143.7	140.8	120.9	88	73.3					26
28	129.9	132.1	132.8	132.2	130	118.4	84.7	71.4	59.3				28
30	119.7	121.8	122.4	121.7	119.8	115.3	81.6	69.4	58.2				30
32	109.7	112	112.8	112.1	113.5	109.2	78.9	67.5	56.9	48.8			32
34	101	103.3	104	105.1	105.5	101.8	76.4	65.5	55.7	47.9			34
36	93.5	95.7	96.4	98.4	97.6	95.2	73.9	63.6	54.4	47	37.7		36
38		88.9	89.6	91.5	90.9	89.2	71.4	61.8	53.2	46.1	37.3	30.3	38
40		83	84	85.6	84.9	83.5	69.1	60.1	51.9	45.2	36.7	30	40
45		70.9	72.4	72.6	71.6	70.3	63.9	55.6	48.6	43	35.4	29	45
50		60.7	62.1	62.2	61.5	60.1	58.4	52	45.3	41	34.2	28	50
55			54.1	54.1	53.3	52	52.9	48.5	42.6	39.2	32.9	26.9	55
60			47.6	47.6	47.8	47.4	46.4	44.6	40	37.3	31.5	25.8	60
65			42.2	42.1	42.4	42.8	40.9	40.8	37.6	35.3	30.3	24.8	65
70				38.4	37.9	38.3	36.8	36.5	35	33.4	29	23.8	70
75				34.5	34.9	34.4	33.5	32.7	31.7	31.4	27.8	22.7	75
80				31.3	31.8	31	31	29.3	29.3	28.5	26.6	21.7	80
85					28.9	28.1	28.1	26.9	26.7	26.2	25.4	20.7	85
90					26.4	25.7	25.6	24.7	24.1	24.6	23.6	19.6	90
95					24.3	23.6	23.8	23.1	21.9	22.3	21.5	18.6	95
100						21.6	21.8	21.7	20.6	20.3	19.5	17.7	100
105						20.2	20	20	19.2	18.5	17.6	16.7	105
110						19.4	18.4	18.4	17.6	16.9	16	15.9	110
115							17.2	16.9	16.1	15.4	14.5	14.5	115
120							15.9	15.6	14.7	14	13.2	13.2	120
125							14.2	14.3	13.5	12.8	12	12.1	125
130								13.2	12.4	11.8	11.1	11.1	130
135								12.3	11.6	11	10.2	10.2	135
140									10.7	10.1	9.4	9.4	140
145									10	9.4	8.6	8.6	145
150									9.4	8.7	7.9	7.9	150
155										8.1	7.3	7.3	155
160										7.5	6.7	6.7	160
165										6.9	6	6	165
170											5.3	5.3	170
175											4.6	4.6	175
180											4	4	180
185												3.4	185



LIFTING CHARTS - All Terrain Cranes

LIEBHERR MODEL LTM 1160-5.2 - 190 TON CAPACITY

Lifting capacities Forces de levage

T

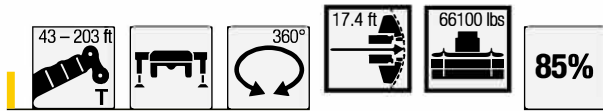

	43 ft	57 ft	72 ft	87 ft	102 ft	116 ft	131 ft	146 ft	161 ft	176 ft	191 ft	203 ft	
10	189.6	189.6	189.6										10
11	189.6	189.6	189.6	189.6									11
12	189.6	189.6	189.6	189.6									12
13	189.6	189.6	189.6	189.6									13
14	189.6	189.6	189.6	189.6									14
15	189.6	189.6	189.6	189.6	166.6								15
16	189.6	189.6	189.6	189.6	165.4								16
17	189.6	189.6	189.6	189.6	164.2								17
18	189.6	189.6	189.6	189.6	163	131.3							18
19	187.2	189.2	187.5	186.9	161.8	130							19
20	181.3	181.8	181.7	180.6	160.6	128.7							20
22	165.7	166.4	167.8	167.7	158.1	126.1	94.6						22
24	150	152.2	153	152.1	146.6	123.5	91.3	74.7					24
26	136.3	138.7	139.3	138.5	133.4	120.9	88	73.3					26
28	123.2	125.8	126.7	126	123	117.3	84.7	71.4	59.3				28
30	112.1	114.6	115.4	115.4	115.5	108.2	81.6	69.4	58.2				30
32	102.6	105	105.8	107.4	106.2	99.7	78.9	67.5	56.9	48.8			32
34	93.9	96.4	97.2	99.4	98.3	92.2	76.4	65.5	55.7	47.9			34
36	86	88.5	90.7	91.5	90.7	85.6	73.9	63.6	54.4	47	37.7		36
38		82.7	84.4	84.4	83.7	79.9	71.4	61.8	53.2	46.1	37.3	30.3	38
40		76.6	78.3	78.4	77.6	74.8	69.1	60.1	51.9	45.2	36.7	30	40
45		64.2	65.8	65.9	65	63.7	61.7	55.6	48.6	43	35.4	29	45
50		54.8	56.3	56.4	55.6	55.6	54.6	50.7	45.3	41	34.2	28	50
55			48.8	48.8	49.2	49.4	47.6	45.9	42.4	39.2	32.9	26.9	55
60			42.8	43.6	43.1	43.5	42	41.1	38.6	36.8	31.5	25.8	60
65			37.9	38.5	39.2	38.5	37.8	36.5	35	33.6	30.3	24.8	65
70				34.4	35	34.3	34.3	32.5	32.1	30.7	28.9	23.8	70
75				30.8	31.4	30.7	30.7	29.8	28.9	28.8	27	22.7	75
80				28.7	28.3	27.9	27.8	27	26.1	26	24.3	21.7	80
85					25.7	25.2	25.4	25.3	24.3	23.5	21.9	20.7	85
90					23.3	23.2	23	23	22.2	21.4	19.8	19.2	90
95					21.3	21.6	21.1	20.8	20	19.2	18	17.6	95
100						19.7	19.1	18.9	18	17.3	16.3	15.9	100
105						18	17.4	17.2	16.3	15.6	14.7	14.4	105
110						16.6	15.9	15.6	14.8	14	13.2	13	110
115							14.5	14.2	13.4	12.6	11.9	11.8	115
120							13.3	12.9	12.2	11.5	10.8	10.7	120
125							12.3	11.9	11.2	10.6	9.8	9.6	125
130								11	10.3	9.7	8.9	8.6	130
135								10.3	9.5	8.9	8	7.7	135
140									8.7	8.1	7.1	6.9	140
145									8.1	7.4	6.3	6.1	145
150									7.5	6.6	5.5	5.4	150
155										5.8	4.7	4.7	155
160										5.2	4	4	160
165										4.6	3.3	3.3	165



LIFTING CHARTS - All Terrain Cranes

LIEBHERR MODEL LTM 1160-5.2 - 190 TON CAPACITY

Lifting capacities Forces de levage

T

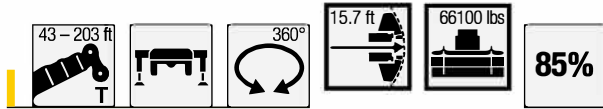

	43 ft	57 ft	72 ft	87 ft	102 ft	116 ft	131 ft	146 ft	161 ft	176 ft	191 ft	203 ft		
10	189.6	189.6	189.6										10	
11	189.6	189.6	189.6	189.6									11	
12	189.6	189.6	189.6	189.6									12	
13	189.6	189.6	189.6	189.6									13	
14	189.6	189.6	189.6	189.6									14	
15	189.6	189.6	189.6	189.6	166.6								15	
16	189.6	189.6	189.6	189.6	165.4								16	
17	189.6	189.6	189.6	189.6	164.2								17	
18	189.4	188.3	189.5	189	163	131.3							18	
19	185.8	186.4	186.2	185.2	161.8	130							19	
20	177.9	178.8	178.3	177.2	160.6	128.7							20	
22	161.6	163.1	164.1	163.8	156.2	126.1	94.6						22	
24	146.2	148.4	149.2	148.3	142.3	123.5	91.3	74.7					24	
26	132.4	134.8	135.4	134.8	129	120.4	88	73.3					26	
28	119.5	122	122.9	122.3	121	113.7	84.7	71.4	59.3				28	
30	108.6	111.2	112	113.8	111.3	104.1	81.6	69.4	58.2				30	
32	99.4	101.8	102.5	104.7	102.3	95.9	78.9	67.5	56.9	48.8			32	
34	90.5	93.1	95.2	96.2	94.8	88.7	76.4	65.5	55.7	47.9			34	
36	82.9	86	88.3	88.4	87.6	82.3	73.9	63.6	54.4	47	37.7		36	
38		79.8	81.5	81.5	80.8	76.8	71.4	61.8	53.2	46.1	37.3	30.3	38	
40		73.9	75.5	75.7	74.9	71.8	67.3	60.1	51.9	45.2	36.7	30	40	
45		61.9	63.4	63.5	62.6	61.1	60	55.6	48.6	43	35.4	29	45	
50			52.8	54.2	54.3	54.2	54.5	52.2	49.4	45.3	41	34.2	28	50
55				47	47.2	47.4	47.7	45.7	44.4	41.4	39.2	32.9	26.9	55
60				41.1	41.9	42.5	41.8	40.9	39.2	37.3	36	31.5	25.8	60
65				36.4	37	37.7	36.9	36.9	34.8	34.2	32.4	30.3	24.8	65
70					33	33.6	32.8	32.9	32	30.5	30.3	28.5	23.8	70
75					30.4	30.1	29.6	29.4	28.6	27.4	27.3	25.5	22.7	75
80					27.5	27.1	26.6	26.9	26.7	25.7	24.6	22.9	21.7	80
85						24.5	24.4	24.3	24.3	23.5	22.2	20.6	20.1	85
90						22.2	22.7	22.1	21.9	21	20.1	18.6	18.2	90
95						20.2	20.6	20	19.8	18.9	18.1	16.8	16.4	95
100							18.7	18.2	17.9	17	16.3	15.1	14.8	100
105							17.1	16.5	16.2	15.4	14.6	13.7	13.3	105
110							15.7	15	14.7	13.9	13.1	12.3	12	110
115								13.7	13.3	12.5	11.9	11.1	10.8	115
120								12.5	12.2	11.5	10.9	10	9.7	120
125								11.7	11.3	10.5	9.9	9	8.7	125
130									10.4	9.7	9	8	7.8	130
135									9.6	8.9	8.2	7.1	6.9	135
140										8.2	7.5	6.3	6.1	140
145										7.5	6.6	5.5	5.4	145
150										6.8	5.9	4.7	4.7	150
155											5.2	4	4	155
160											4.5	3.3	3.3	160
165											3.9			165



LIFTING CHARTS - All Terrain Cranes

LIEBHERR MODEL LTM 1160-5.2 - 190 TON CAPACITY

Lifting capacities Forces de levage

T

43 - 203 ft

360°

17.4 ft

49600 lbs

85%

	43 ft	57 ft	72 ft	87 ft	102 ft	116 ft	131 ft	146 ft	161 ft	176 ft	191 ft	203 ft	
10	189.6	189.6	189.6										10
11	189.6	189.6	189.6	189.6									11
12	189.6	189.6	189.6	189.6									12
13	189.6	189.6	189.6	189.6									13
14	189.6	189.6	189.6	189.6									14
15	189.6	189.6	189.6	189.6	166.6								15
16	189.6	189.6	189.6	189.6	165.4								16
17	189.6	189.6	189.6	189.6	164.2								17
18	189.1	188	189.2	187.5	163	131.3							18
19	184.6	185.7	185.2	182.1	161.8	130							19
20	175.1	176	175.7	175.4	160.6	128.7							20
22	156.9	159.3	159.7	157.5	144.7	126.1	94.6						22
24	140	142.6	143.3	139.3	130.5	122.4	91.3	74.7					24
26	125.3	127.7	128.8	124.7	120.5	111.9	88	73.3					26
28	113	115.4	116.4	116.8	109.3	101.7	84.7	71.4	59.3				28
30	101.3	104.2	105.2	106.1	99.7	93	81.6	69.4	58.2				30
32	91.6	94.2	97.3	97.2	91.5	85.5	78.4	67.5	56.9	48.8			32
34	83.2	87	88.8	89	84.7	78.9	73.8	65.5	55.7	47.9			34
36	76.1	79.8	81.5	81.6	78.3	73	69.7	63.6	54.4	47	37.7		36
38		73.4	75.1	75.1	72.6	67.6	66.1	61.5	53.2	46.1	37.3	30.3	38
40		67.9	69.6	69.7	67.5	65.1	61.6	57.5	51.9	45.2	36.7	30	40
45		56.2	57.9	58	58.4	56.9	52.9	50.6	47.5	43	35.4	29	45
50		46.7	48.3	49.3	49.5	49	46.3	43.7	41.9	39.8	34.2	28	50
55			41.1	42	42.8	42	41.6	39.1	37.2	35.8	32.9	26.9	55
60			35.7	37.2	37	36.6	36.4	34.5	33	32.4	30.3	25.8	60
65			31.2	32.6	32.4	31.9	32.2	32	30.3	28.7	26.8	24.8	65
70				28.8	28.6	28.9	28.6	28.5	27.2	25.5	23.7	22.9	70
75				25.7	25.4	26	25.5	25.3	24.3	22.7	21	20.6	75
80				23.1	22.9	23.3	22.8	22.6	21.8	20.3	18.7	18.3	80
85					20.8	21	20.5	20.3	19.5	18.2	16.7	16.3	85
90					18.8	19	18.5	18.2	17.4	16.3	14.9	14.5	90
95					17.2	17.2	16.7	16.4	15.5	14.7	13.2	12.9	95
100						15.7	15.1	14.8	13.8	13	11.8	11.5	100
105						14.3	13.6	13.3	12.4	11.6	10.4	10.2	105
110						13	12.3	12	11.1	10.2	9.2	9	110
115							11.1	10.8	9.9	9.1	8.1	7.9	115
120							10.1	9.7	8.8	8	7	6.9	120
125							9.3	8.7	7.8	7	6	6	125
130								7.9	6.9	6.1	5.2	5.2	130
135								7.1	6.1	5.3	4.3	4.4	135
140									5.4	4.6	3.6	3.6	140
145									4.7	3.9			145
150									4.1				150



LIFTING CHARTS - All Terrain Cranes

LIEBHERR MODEL LTM 1160-5.2 - 190 TON CAPACITY

Lifting capacities Forces de levage

T

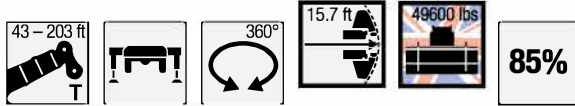

	43 ft	57 ft	72 ft	87 ft	102 ft	116 ft	131 ft	146 ft	161 ft	176 ft	191 ft	203 ft		
10	189.6	189.6	189.6										10	
11	189.6	189.6	189.6	189.6									11	
12	189.6	189.6	189.6	189.6									12	
13	189.6	189.6	189.6	189.6									13	
14	189.6	189.6	189.6	189.6									14	
15	189.6	189.6	189.6	189.6	166.6								15	
16	189.6	189.6	189.6	189.6	165.4								16	
17	189.6	189.6	189.6	189.6	164.2								17	
18	188	187	188.2	185.8	163	131.3							18	
19	182.3	183.6	182.9	179.3	161.1	130							19	
20	172.4	173.7	173.1	172.8	157.6	128.7							20	
22	154.4	156.8	157.2	153.8	141.1	125.9	94.6						22	
24	137.4	140	140.8	135.9	130.2	121	91.3	74.7					24	
26	122.9	125.3	126.4	124.2	117.5	109.1	88	73.3					26	
28	110.5	113.1	113.9	114	106.5	99.1	84.7	71.4	59.3				28	
30	99	101.9	104.1	103.4	97.2	90.6	81.6	69.4	58.2				30	
32	89.4	92.7	95.2	95	89.2	83.2	77.9	67.5	56.9	48.8			32	
34	81.2	85	86.8	87	82.5	76.8	71.7	65.5	55.7	47.9			34	
36	74.2	77.9	79.6	79.8	76.2	70.9	69.2	63.2	54.4	47	37.7		36	
38		71.7	73.4	73.4	70.6	67.3	64.2	60	53.2	46.1	37.3	30.3	38	
40		66.3	67.9	68.1	65.6	63.7	59.8	56.8	51.9	45.2	36.7	30	40	
45		54.6	56.4	56.5	56.8	55.3	51.9	49.1	46	43	35.4	29	45	
50		45.4	47	48	48.7	47.6	45.9	42.7	41.2	38.5	34.2	28	50	
55			40	40.9	41.6	40.9	40.3	38	36	35.5	32.7	26.9	55	
60			34.6	36.1	36	35.6	35.3	34.3	32.6	31.3	29.2	25.8	60	
65			30.2	31.6	31.4	31	31.3	31.2	29.4	27.6	25.8	24.6	65	
70				27.9	27.7	28.4	27.9	27.6	26.2	24.5	22.8	22.3	70	
75				24.9	24.6	25.2	24.7	24.5	23.4	21.8	20.1	19.7	75	
80				22.3	22.4	22.6	22.1	21.8	21	19.5	17.9	17.5	80	
85					20.2	20.3	19.8	19.6	18.8	17.4	15.9	15.5	85	
90					18.2	18.3	17.8	17.6	16.7	15.6	14.1	13.8	90	
95					16.6	16.6	16.1	15.8	14.9	14	12.5	12.2	95	
100							15.1	14.5	14.2	13.2	12.4	11.1	10.8	100
105							13.7	13	12.7	11.8	11	9.8	9.5	105
110							12.5	11.8	11.4	10.5	9.7	8.6	8.4	110
115								10.6	10.3	9.4	8.5	7.6	7.3	115
120								9.6	9.2	8.3	7.5	6.5	6.4	120
125								8.8	8.3	7.4	6.6	5.6	5.5	125
130									7.4	6.5	5.7	4.7	4.7	130
135									6.7	5.7	4.9	3.9	3.9	135
140										5	4.2			140
145										4.3	3.5			145
150										3.8				150



LIFTING CHARTS - All Terrain Cranes

LIEBHERR MODEL LTM 1160-5.2 - 190 TON CAPACITY

Lifting capacities Forces de levage

T

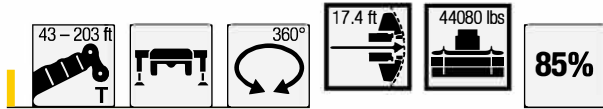

	43 ft	57 ft	72 ft	87 ft	102 ft	116 ft	131 ft	146 ft	161 ft	176 ft	191 ft	203 ft	
10	189.6	189.6	189.6										10
11	189.6	189.6	189.6	189.6									11
12	189.6	189.6	189.6	189.6									12
13	189.6	189.6	189.6	189.6									13
14	189.6	189.6	189.6	189.6									14
15	189.6	189.6	189.6	189.6	166.6								15
16	189.6	189.6	189.6	189.6	165.4								16
17	189.6	189.6	189.6	189.6	164.2								17
18	188.4	187	188.7	185.7	163	131.3							18
19	182.8	183.6	183.5	178.2	160.5	130							19
20	172.3	173.6	173	171.9	155	128.7							20
22	153.9	156.3	157.1	150.4	137.9	125.6	94.6						22
24	136.4	139.1	140	132.8	127.7	118.2	91.3	74.7					24
26	122	124.5	125.5	123	114.9	106.6	88	73.3					26
28	109	111.9	112.7	111.4	104.1	96.8	84.7	71.4	59.3				28
30	97.6	100.5	103.5	101.1	95	88.5	80.8	69.4	58.2				30
32	88.1	91.7	93.9	92.8	87.1	81.1	75.6	67.5	56.9	48.8			32
34	80	83.8	85.6	85.4	80.3	74.5	71.3	65.5	55.7	47.9			34
36	73.1	76.8	78.5	78.6	73.9	69.9	67	62.6	54.4	47	37.7		36
38		70.6	72.3	72.4	68.4	66.9	62.2	58.2	53.2	46.1	37.3	30.3	38
40		65.1	66.8	67	63.6	62.5	58.2	55.8	51.4	45.2	36.7	30	40
45		52.9	54.6	54.8	55	53.5	50.4	47.4	44.8	42.5	35.4	29	45
50		43.9	45.5	46.4	47.3	46.1	44.6	41.9	39.8	37.7	34.2	28	50
55			38.8	40.4	40.3	39.7	38.9	36.6	35.1	34.2	31.9	26.9	55
60			33.5	34.9	34.8	34.4	34.6	33.7	32	30.1	28.1	25.8	60
65			29.2	30.5	30.3	30.3	30.3	30.2	28.3	26.6	24.7	24.1	65
70				26.9	26.7	27.4	26.9	26.6	25.2	23.5	21.8	21.3	70
75				24	24.1	24.3	23.8	23.6	22.5	20.9	19.2	18.8	75
80				21.5	21.6	21.8	21.3	21	20.1	18.6	17	16.6	80
85					19.4	19.5	19	18.8	18	16.6	15.1	14.7	85
90					17.5	17.6	17.1	16.9	16	14.8	13.3	13	90
95					15.9	15.9	15.4	15.1	14.2	13.2	11.8	11.5	95
100						14.4	13.8	13.5	12.6	11.7	10.4	10.1	100
105						13	12.4	12.1	11.2	10.3	9.1	8.9	105
110						11.9	11.2	10.8	9.9	9.1	8	7.8	110
115							10	9.7	8.8	8	6.9	6.7	115
120							9.1	8.7	7.8	7	6	5.8	120
125							8.3	7.8	6.8	6	5.1	4.9	125
130								6.9	6	5.2	4.2	4.1	130
135								6.2	5.2	4.4	3.4	3.3	135
140									4.5	3.7			140
145									3.9				145
150									3.3				150





LIFTING CHARTS - All Terrain Cranes

LIEBHERR MODEL LTM 1160-5.2 - 190 TON CAPACITY

Lifting capacities Forces de levage

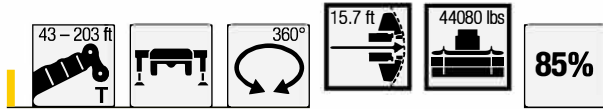
T



	43 ft	57 ft	72 ft	87 ft	102 ft	116 ft	131 ft	146 ft	161 ft	176 ft	191 ft	203 ft	
10	189.6	189.6	189.6										10
11	189.6	189.6	189.6	189.6									11
12	189.6	189.6	189.6	189.6									12
13	189.6	189.6	189.6	189.6									13
14	189.6	189.6	189.6	189.6									14
15	189.6	189.6	189.6	189.6	166.6								15
16	189.6	189.6	189.6	189.6	165.4								16
17	189.6	189.6	189.6	189.6	164.2								17
18	186.7	185.4	187	183.7	163	131.3							18
19	179.6	180.4	180.2	174.5	159.7	130							19
20	169.2	170.5	170	167	151.6	128.7							20
22	150.6	153.1	153.9	146	134.8	125.2	94.6						22
24	133.4	136	137	129.6	124	114.7	91.3	74.7					24
26	119.3	121.7	122.8	119.4	111.5	103.4	88	73.3					26
28	106.1	109	110.3	108.2	101	93.9	84.7	71.4	59.3				28
30	94.9	97.8	101	98.1	92.1	85.7	79.9	69.4	58.2				30
32	85.7	89.6	91.5	90.1	84.4	78.5	73.4	67.5	56.9	48.8			32
34	77.8	81.5	83.4	82.8	77.8	72	70.1	64.4	55.7	47.9			34
36	71	74.7	76.4	76.2	71.5	69.1	64.7	60.4	54.4	47	37.7		36
38		68.7	70.4	70.3	66.1	65.3	60.3	58	52.9	46.1	37.3	30.3	38
40		63.2	65	65	62.6	61	57.1	54	50.5	45.2	36.7	30	40
45		51.1	52.8	53.6	54.2	51.7	49.3	46.3	44.4	41.4	35.4	29	45
50			42.3	44	44.9	45.8	44.5	43.1	40.6	38.3	37.2	34.1	50
55				37.5	39.1	38.9	38.5	37.6	36.4	34.5	32.8	30.8	55
60				32.3	33.8	33.6	33.2	33.5	32.7	30.7	28.9	26.8	60
65				28.1	29.5	29.3	29.9	29.5	29	27.2	25.4	23.6	65
70					26	26.1	26.4	25.9	25.6	24.1	22.4	20.7	70
75					23.1	23.2	23.4	22.9	22.7	21.5	19.9	18.2	75
80					20.7	20.7	20.9	20.4	20.2	19.2	17.7	16.1	80
85						18.6	18.8	18.3	18	17.1	15.7	14.2	85
90						16.8	16.9	16.4	16.1	15.2	14	12.5	90
95						15.1	15.2	14.7	14.3	13.4	12.4	11	95
100							13.7	13.1	12.8	11.9	11.1	9.7	100
105							12.4	11.8	11.4	10.5	9.7	8.4	105
110							11.3	10.6	10.2	9.3	8.5	7.3	110
115								9.5	9.1	8.2	7.4	6.3	115
120								8.5	8.1	7.2	6.4	5.4	120
125								7.7	7.2	6.3	5.5	4.5	125
130									6.4	5.5	4.7	3.7	130
135									5.7	4.7	3.9		135
140										4.1			140
145										3.4			145



LIFTING CHARTS - All Terrain Cranes

LIEBHERR MODEL LTM 1160-5.2 - 190 TON CAPACITY

Lifting capacities Forces de levage

T

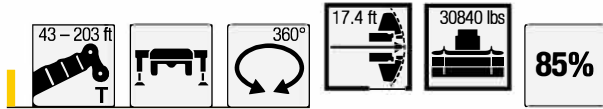

	43 ft	57 ft	72 ft	87 ft	102 ft	116 ft	131 ft	146 ft	161 ft	176 ft	191 ft	203 ft	
10	189.6	189.6	189.6										10
11	189.6	189.6	189.6	189.6									11
12	189.6	189.6	189.6	189.6									12
13	189.6	189.6	189.6	189.6									13
14	189.6	189.6	189.6	189.6									14
15	189.6	189.6	189.6	189.6	166.6								15
16	189.6	189.6	189.6	187.8	165.4								16
17	189.6	189.6	189.6	182.8	164								17
18	183.6	182.8	184.2	171	155.3	131.3							18
19	174	174.9	173.1	161.4	146.2	130							19
20	163.4	164.1	163.7	149.3	137.7	127.5							20
22	142.6	145.5	141.4	132.9	124.4	114.3	94.6						22
24	125.6	128.6	124.4	119.2	110.5	101.9	91.2	74.7					24
26	110.1	113	113.2	106.5	99.2	91.4	84.3	73.3					26
28	97.4	100.9	102	96.1	89.3	82.1	77.1	71.2	59.3				28
30	87	91.2	92	86.5	80.6	76.5	71.9	66.3	58.2				30
32	78.4	82.3	83.2	78.7	73.5	72.1	66.5	62.3	56.4	48.8			32
34	69.9	74.3	75.7	71.9	68.5	66.2	61.7	58	53.9	47.9			34
36	62.3	66.7	68.8	65.9	64.3	61	57.7	53.5	50.4	46.8	37.7		36
38		60.1	62.2	61.7	60	56.6	54.3	50.9	47.7	44.5	37.3	30.3	38
40		54.6	56.5	57.3	56	52.6	50.5	47.3	44.6	41.4	36.7	30	40
45		43.8	45.8	47.6	47	44.7	42.8	41.5	39.3	37	34.4	29	45
50		36.1	38	39.6	39.5	38.5	37.6	36.2	33.8	31.7	29.5	28	50
55			32	33.5	33.4	34.1	32.7	31.4	29.4	27.3	25.4	24.7	55
60			27.3	28.8	29.1	29.4	28.7	27.5	25.6	23.8	21.9	21.3	60
65			23.6	25	25.3	25.5	25	24.2	22.4	20.7	19	18.4	65
70				21.9	22.1	22.4	21.9	21.3	19.7	18.1	16.5	16.1	70
75				19.3	19.5	19.7	19.2	18.9	17.3	15.8	14.2	13.9	75
80				17.2	17.3	17.5	17	16.7	15.3	13.9	12.4	12	80
85					15.4	15.5	15	14.7	13.5	12.1	10.7	10.4	85
90					13.6	13.8	13.2	12.9	11.9	10.6	9.2	8.9	90
95					12.2	12.3	11.7	11.3	10.4	9.2	7.8	7.6	95
100						10.9	10.3	10	9	8	6.6	6.4	100
105						9.7	9.1	8.8	7.8	6.9	5.6	5.3	105
110						8.7	8	7.7	6.8	5.9	4.5	4.4	110
115							7.1	6.7	5.8	5	3.5		115
120							6.2	5.8	4.9	4.1			120
125							5.6	5	4.1				125
130								4.3	3.4				130
135								3.7					135



LIFTING CHARTS - All Terrain Cranes

LIEBHERR MODEL LTM 1160-5.2 - 190 TON CAPACITY

Lifting capacities Forces de levage

T

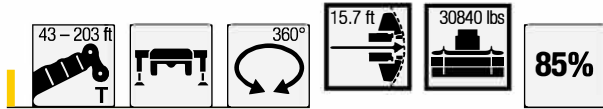

	43 ft	57 ft	72 ft	87 ft	102 ft	116 ft	131 ft	146 ft	161 ft	176 ft	191 ft	203 ft	
10	189.6	189.6	189.6										10
11	189.6	189.6	189.6	189.6									11
12	189.6	189.6	189.6	189.6									12
13	189.6	189.6	189.6	189.6									13
14	189.6	189.6	189.6	189.6									14
15	189.6	189.6	189.6	189.6	166.6								15
16	189.6	189.6	189.6	187.1	165.4								16
17	189.6	189.6	189.6	180	164								17
18	182.7	182	182.7	169.3	153.8	131.3							18
19	172.2	173.2	170.1	158.7	143.7	130							19
20	161.4	162.5	161	146.8	136.3	127.3							20
22	140.8	143.8	139	132.1	122.3	112.3	94.6						22
24	123.8	126.8	123.3	117.2	108.6	100.1	90	74.7					24
26	108.4	111.3	111.7	104.7	97.4	89.6	82.6	73.3					26
28	96	100.2	100.2	94.4	87.5	80.4	76.4	71.1	59.3				28
30	85.7	89.8	90.3	84.8	79	76.2	70.5	65.9	58.2				30
32	77.1	81.1	81.6	77.2	73.2	70.6	65.8	61.5	55.9	48.8			32
34	68.5	73	74.2	70.5	67.6	64.8	60.4	56.7	52.7	47.9			34
36	61.1	65.5	67.5	64.5	63.8	59.8	57.3	52.8	50.1	46.1	37.7		36
38		59	61	60.5	59	55.4	53.1	49.8	46.9	43.5	37.3	30.3	38
40		53.5	55.5	56.1	54.8	51.6	49.4	46.3	43.6	41.4	36.7	30	40
45		42.9	45	46.8	46	43.7	42.3	41.1	38.5	36.2	33.7	29	45
50		35.3	37.2	38.9	38.7	38.3	36.9	35.4	33	30.9	28.7	27.8	50
55			31.3	32.9	32.7	33.4	32	30.7	28.7	26.6	24.7	24	55
60			26.7	28.2	28.5	28.8	28	26.8	24.9	23.1	21.2	20.7	60
65			23.1	24.5	24.7	25	24.5	23.5	21.8	20.1	18.4	17.9	65
70				21.4	21.6	21.9	21.3	20.8	19.1	17.6	15.9	15.5	70
75				18.9	19.1	19.3	18.8	18.4	16.8	15.3	13.7	13.4	75
80				16.8	16.9	17.1	16.6	16.3	14.8	13.4	11.9	11.5	80
85					14.9	15.1	14.6	14.3	13.1	11.7	10.2	9.9	85
90					13.2	13.4	12.8	12.5	11.5	10.2	8.7	8.5	90
95					11.8	11.9	11.3	11	10.1	8.8	7.4	7.2	95
100						10.5	9.9	9.6	8.7	7.6	6.2	6	100
105						9.4	8.8	8.4	7.5	6.5	5.2	4.9	105
110						8.4	7.7	7.4	6.5	5.6	4.1	3.9	110
115							6.8	6.4	5.5	4.7			115
120							5.9	5.5	4.6	3.8			120
125							5.3	4.8	3.8				125
130								4.1					130
135								3.4					135



LIFTING CHARTS - All Terrain Cranes

LIEBHERR MODEL LTM 1160-5.2 - 190 TON CAPACITY

Lifting capacities Forces de levage

T

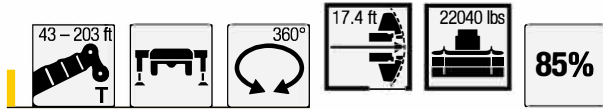

	43 ft	57 ft	72 ft	87 ft	102 ft	116 ft	131 ft	146 ft	161 ft	176 ft	191 ft	203 ft	
10	189.6	189.6	189.6										10
11	189.6	189.6	189.6	189.6									11
12	189.6	189.6	189.6	189.6									12
13	189.6	189.6	189.6	189.6									13
14	189.6	189.6	189.6	189.6									14
15	189.6	189.6	189.6	189.6	166.6								15
16	189.6	189.6	189.6	184.1	162.2								16
17	188.6	189.6	184.9	173.2	156.5								17
18	180.5	180.3	173.2	160.6	144.8	130.4							18
19	168.6	171.2	163	148	137.2	124.7							19
20	156.5	159.7	150.2	140.3	129.4	118.6							20
22	136.5	139.2	130	123.8	114	104.4	93.1						22
24	118	121.1	116.7	109.3	100.8	91.9	84.3	74.7					24
26	103.1	106.6	103.7	96.9	89.4	81.9	77.8	71.8					26
28	91.2	95.4	92.3	86.6	79.9	77.3	71.2	67.3	59.3				28
30	80.9	85.2	82.6	77.6	73.8	70.7	65.7	61.2	56				30
32	70.7	75.5	74.5	70.4	68.8	64.5	61	56.5	52.5	48			32
34	62.2	66.8	67.7	65.4	63.4	59.1	56.5	52.8	49.5	45.7			34
36	55.3	59.7	61.6	59.9	58.2	54.9	52.1	48.7	45.7	43	37.7		36
38		53.7	55.7	56.4	53.8	50.9	48.4	45.4	43.1	41.2	36.9	30.3	38
40		48.6	50.9	52.4	49.9	47.2	45.6	43.8	41.1	38.4	35.6	30	40
45		38.8	40.8	42.6	41.7	41.1	39	37.1	34.7	32.4	30.1	28.4	45
50			31.7	33.6	35.3	35.3	35.2	33.3	31.8	29.5	27.5	25.4	50
55				28.2	29.7	30.1	30.3	28.7	27.5	25.5	23.5	21.6	55
60				23.9	25.4	25.7	26	25	23.9	22	20.3	18.5	60
65				20.6	22	22.2	22.4	21.9	20.8	19.1	17.5	15.8	65
70					19.1	19.4	19.6	19.1	18.2	16.6	15.1	13.5	70
75					16.8	17	17.2	16.6	16.1	14.5	13.1	11.5	75
80					14.7	14.8	15.1	14.5	14.1	12.7	11.3	9.8	80
85						13	13.2	12.6	12.3	11	9.7	8.2	85
90						11.4	11.6	11	10.7	9.6	8.3	6.9	90
95						10.1	10.2	9.6	9.3	8.3	7	5.7	95
100							9	8.3	8	7.1	5.9	4.5	100
105							7.9	7.3	6.9	6	4.9		105
110							7	6.3	5.9	5	3.9		110
115								5.4	5	4.1			115
120								4.6	4.2				120
125								4.1	3.5				125



LIFTING CHARTS - All Terrain Cranes

LIEBHERR MODEL LTM 1160-5.2 - 190 TON CAPACITY

Lifting capacities Forces de levage

T

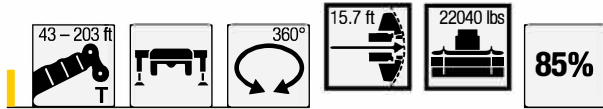

	43 ft	57 ft	72 ft	87 ft	102 ft	116 ft	131 ft	146 ft	161 ft	176 ft	191 ft	203 ft	
10	189.6	189.6	189.6										10
11	189.6	189.6	189.6	189.6									11
12	189.6	189.6	189.6	189.6									12
13	189.6	189.6	189.6	189.6									13
14	189.6	189.6	189.6	189.6									14
15	189.6	189.6	189.6	189.1	166.6								15
16	189.6	189.6	189.6	182.6	160.9								16
17	187.3	189.6	182.8	170.4	153.7								17
18	178.6	179.2	170.1	157.8	142.1	130.2							18
19	166.6	169.1	160.1	145.3	136.8	123.3							19
20	154.5	157.7	147.5	139	127.7	116.4							20
22	134.6	136.9	129.8	121.6	111.9	102.4	91.7						22
24	116.2	119.2	115	107.3	98.8	90	82.9	74.2					24
26	101.5	105.7	101.7	94.9	87.5	81.7	76.9	70.6					26
28	89.7	93.9	90.4	84.8	78.6	76.4	70.5	65.8	59.3				28
30	79.4	83.8	80.8	75.9	73.1	69.2	64.2	59.8	55.1				30
32	69.2	74	72.9	69	67.5	63.1	60.2	55.7	52	47.6			32
34	60.8	65.4	66.2	64	62	58.3	55.3	51.6	48.3	44.6			34
36	54	58.4	60.2	59.1	56.9	53.7	50.9	47.6	44.6	42.5	37.7		36
38		52.5	54.5	55.2	52.6	49.7	47.9	45.3	42.5	40.4	36.6	30.3	38
40		47.6	49.8	51.2	48.7	46.1	44.9	42.8	40.1	37.5	34.7	30	40
45		37.9	40	41.7	40.7	40.1	38.1	36.2	33.8	31.5	29.2	28	45
50			31	32.8	34.5	34.8	34.3	32.4	31	28.8	26.8	24.6	50
55				27.5	29.1	29.4	29.6	27.9	26.7	24.8	22.8	21	55
60				23.3	24.8	25.1	25.4	24.3	23.2	21.4	19.7	17.8	60
65				20	21.4	21.7	21.9	21.2	20.2	18.5	16.9	15.3	65
70					18.6	18.9	19.1	18.5	17.7	16.1	14.6	13	70
75					16.3	16.5	16.7	16.2	15.5	14	12.5	11	75
80					14.3	14.4	14.6	14	13.6	12.2	10.8	9.3	80
85						12.6	12.8	12.2	11.9	10.6	9.2	7.8	85
90						11	11.2	10.6	10.3	9.1	7.8	6.5	90
95						9.7	9.8	9.2	8.9	7.9	6.6	5.2	95
100							8.6	8	7.7	6.8	5.5	4	100
105							7.6	6.9	6.6	5.7	4.5		105
110							6.7	6	5.6	4.7	3.4		110
115								5.1	4.8	3.8			115
120								4.4	4				120
125								3.8					125



LIFTING CHARTS - All Terrain Cranes

LIEBHERR MODEL LTM 1160-5.2 - 190 TON CAPACITY

Lifting capacities Forces de levage

T

43 - 203 ft

360°

17.4 ft

7720 lbs

85%

	43 ft	57 ft	72 ft	87 ft	102 ft	116 ft	131 ft	146 ft	161 ft	176 ft	191 ft	203 ft	
10	189.6	189.6	189.6										10
11	189.6	189.6	189.6	189.6									11
12	189.6	189.6	189.6	189.6									12
13	189.6	189.6	189.6	189.4									13
14	189.6	189.6	189.6	188.6									14
15	189.6	189.6	189.6	172.4	156.9								15
16	189.6	189.6	175.1	161.2	143.2								16
17	180.2	178.2	162.1	146.2	136.6								17
18	167.7	162.3	149	137.8	126.3	113							18
19	154.8	149.1	137	128.4	116.5	104.3							19
20	142.9	137.1	129.1	118.8	107.4	96							20
22	120.4	115.8	110.3	101.5	92	87.1	78.7						22
24	103.6	100.5	95.1	87.9	82.6	77.6	71.3	65.6					24
26	89	86.7	83	78.5	74.8	69.6	65.2	60.1					26
28	74.9	76.1	73.3	71	66.9	62.5	58.6	54	50.1				28
30	63.7	67.4	65.3	64	60.2	56.4	53.9	50.7	46.6				30
32	55.1	59.8	59.1	58.1	54.6	52.4	49.6	46.9	43.5	40.3			32
34	48.2	52.8	53.5	52.8	49.9	48.4	45.5	43	39.9	36.9			34
36	42.5	46.9	48.6	48.2	46.4	44.5	41.8	39.6	36.7	34	31.3		36
38		41.9	44.3	44.2	42.7	41.1	38.5	36.5	33.9	31.3	28.8	27.8	38
40		37.8	40	40.8	39.5	38.1	35.7	33.8	31.3	28.9	26.5	25.5	40
45		29.7	31.7	33.5	32.7	31.7	29.8	28.2	26	23.9	21.8	21	45
50		23.9	25.8	27.4	27.6	26.8	25.1	23.8	21.7	19.9	17.9	17.3	50
55			21.3	22.8	23.2	22.8	21.3	20.2	18.4	16.6	14.8	14.3	55
60			17.7	19.3	19.6	19.6	18.2	17.2	15.5	13.9	12.2	11.8	60
65			14.8	16.4	16.7	16.9	15.6	14.7	13.1	11.6	10.1	9.6	65
70				13.9	14.2	14.4	13.4	12.6	11.1	9.7	8.1	7.8	70
75				11.8	12	12.3	11.6	10.8	9.3	7.9	6.4	6.1	75
80				10.1	10.2	10.5	9.9	9.2	7.8	6.4	4.8	4.4	80
85					8.7	8.9	8.3	7.9	6.4	5.1			85
90					7.4	7.6	7	6.6	5.2	3.5			90
95					6.3	6.4	5.8	5.5	3.9				95
100						5.4	4.8	4.4					100
105						4.5	3.8						105
110						3.8							110



LIFTING CHARTS - All Terrain Cranes

LIEBHERR MODEL LTM 1160-5.2 - 190 TON CAPACITY

Lifting capacities Forces de levage

T

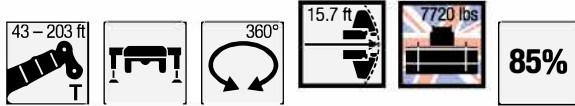

	43 ft	57 ft	72 ft	87 ft	102 ft	116 ft	131 ft	146 ft	161 ft	176 ft	191 ft	203 ft	
10	189.6	189.6	189.6										10
11	189.6	189.6	189.6	189.6									11
12	189.6	189.6	189.6	189.6									12
13	189.6	189.6	189.6	189									13
14	189.6	189.6	189.6	187.3									14
15	189.6	189.6	189.6	171	155.7								15
16	189.6	189.6	174	159.9	142								16
17	179.5	176.9	161.3	145.9	135.5								17
18	166.8	161	147.8	137.2	125.3	112							18
19	153.9	147.9	136.7	127.4	115.5	103.3							19
20	142	136	128.1	117.7	106.4	95							20
22	119.7	114.8	109.3	100.5	91.1	86.2	78.2						22
24	102.9	99.5	94.2	87.1	82.5	76.9	70.6	64.9					24
26	88.2	85.9	82.2	77.8	74.1	69	64.6	59.5					26
28	74.2	75.4	72.6	70.8	66.2	61.8	58	53.5	49.6				28
30	63.1	66.7	64.6	63.4	59.6	55.8	53.4	50.3	46.3				30
32	54.5	59.3	58.5	57.5	54	52.2	49.1	46.4	43.1	39.9			32
34	47.6	52.2	52.9	52.3	49.4	47.9	45	42.6	39.4	36.5			34
36	42	46.4	48.1	47.7	45.9	44	41.3	39.2	36.3	33.6	30.9		36
38		41.5	43.8	43.8	42.3	40.7	38.1	36.1	33.5	30.9	28.4	27.4	38
40		37.4	39.6	40.4	39	37.6	35.3	33.4	30.9	28.5	26.1	25.2	40
45		29.3	31.4	33.1	32.3	31.3	29.5	27.8	25.6	23.6	21.5	20.7	45
50		23.6	25.5	27.1	27.3	26.5	24.8	23.5	21.4	19.6	17.6	17	50
55			21	22.6	22.9	22.5	21	19.9	18.1	16.3	14.6	14.1	55
60			17.5	19	19.3	19.3	18	17	15.3	13.7	12	11.5	60
65			14.6	16.2	16.4	16.7	15.4	14.5	12.9	11.4	9.8	9.4	65
70				13.7	14	14.2	13.2	12.4	10.9	9.4	7.9	7.6	70
75				11.6	11.9	12.1	11.4	10.6	9.1	7.7	6.3	5.9	75
80				10	10.1	10.3	9.7	9	7.6	6.3	4.5	4.2	80
85					8.6	8.8	8.2	7.7	6.3	4.8			85
90					7.3	7.4	6.9	6.4	5				90
95					6.2	6.3	5.7	5.4	3.7				95
100						5.3	4.7	4.3					100
105						4.4	3.6						105
110						3.7							110



LIFTING CHARTS - All Terrain Cranes

LIEBHERR MODEL LTM 1160-5.2 - 190 TON CAPACITY

Lifting capacities Forces de levage

T

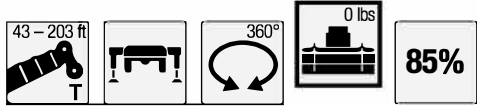

	43 ft	57 ft	72 ft	87 ft	102 ft	116 ft	131 ft	146 ft	161 ft	176 ft	191 ft	203 ft	
10	189.6	189.6	189.6										10
11	189.6	189.6	189.6	189.6									11
12	189.6	189.6	189.6	189.6									12
13	189.6	189.6	189.6	185									13
14	189.6	189.6	187.4	175.2									14
15	189.5	189.6	176.2	160.4	143.9								15
16	188.9	178.2	161	144.1	133.9								16
17	173.7	162.1	146.7	135.4	121.6								17
18	159.2	147.7	135.6	124.2	111	97.6							18
19	145.2	133.1	125.1	113.3	101.1	91.1							19
20	131.2	121.1	113.9	103.3	93.1	88.3							20
22	107.2	102.5	95.6	87.9	83.5	76.4	70.2						22
24	89.3	86.6	82.3	78.3	73.1	67.7	63	56					24
26	75.8	74.5	71.6	69.4	64.6	60	56.9	53					26
28	64	65.1	63.5	61.8	57.6	55.4	51.6	48.3	44.4				28
30	54.2	57.4	56.4	55.1	52.3	50	46.7	43.8	40.4				30
32	46.6	51	50.5	49.8	47.5	45.3	42.4	39.9	36.8	33.8			32
34	40.5	45.1	45.4	45.2	43.4	41.4	38.6	36.5	33.5	30.7			34
36	35.5	39.9	41.2	41.1	39.5	37.9	35.4	33.4	30.7	28.2	25.6		36
38		35.5	37.5	37.6	36.3	34.9	32.5	30.7	28.2	25.8	23.4	22.5	38
40		31.9	34.1	34.6	33.4	32.2	30	28.3	26	23.7	21.4	20.6	40
45		24.7	26.7	28.3	27.4	26.5	24.8	23.3	21.2	19.3	17.3	16.6	45
50		19.5	21.5	23.1	22.9	22.2	20.6	19.5	17.5	15.7	13.8	13.3	50
55			17.4	19	19.2	18.7	17.2	16.3	14.5	12.8	11.1	10.7	55
60			14.1	15.9	16.2	15.8	14.5	13.6	12	10.5	8.8	8.4	60
65			11.5	13.1	13.5	13.4	12.2	11.4	9.9	8.4	6.8	6.4	65
70				10.9	11.2	11.4	10.3	9.5	8	6.6	4.7	4.4	70
75				9.1	9.3	9.6	8.6	7.9	6.5	4.8			75
80				7.6	7.7	8	7.2	6.5	4.9				80
85					6.4	6.6	6	5.2					85
90					5.2	5.4	4.7	3.8					90
95					4.3	4.3	3.3						95



LIFTING CHARTS - All Terrain Cranes

LIEBHERR MODEL LTM 1160-5.2 - 190 TON CAPACITY

Lifting heights Hauteurs de levage

T

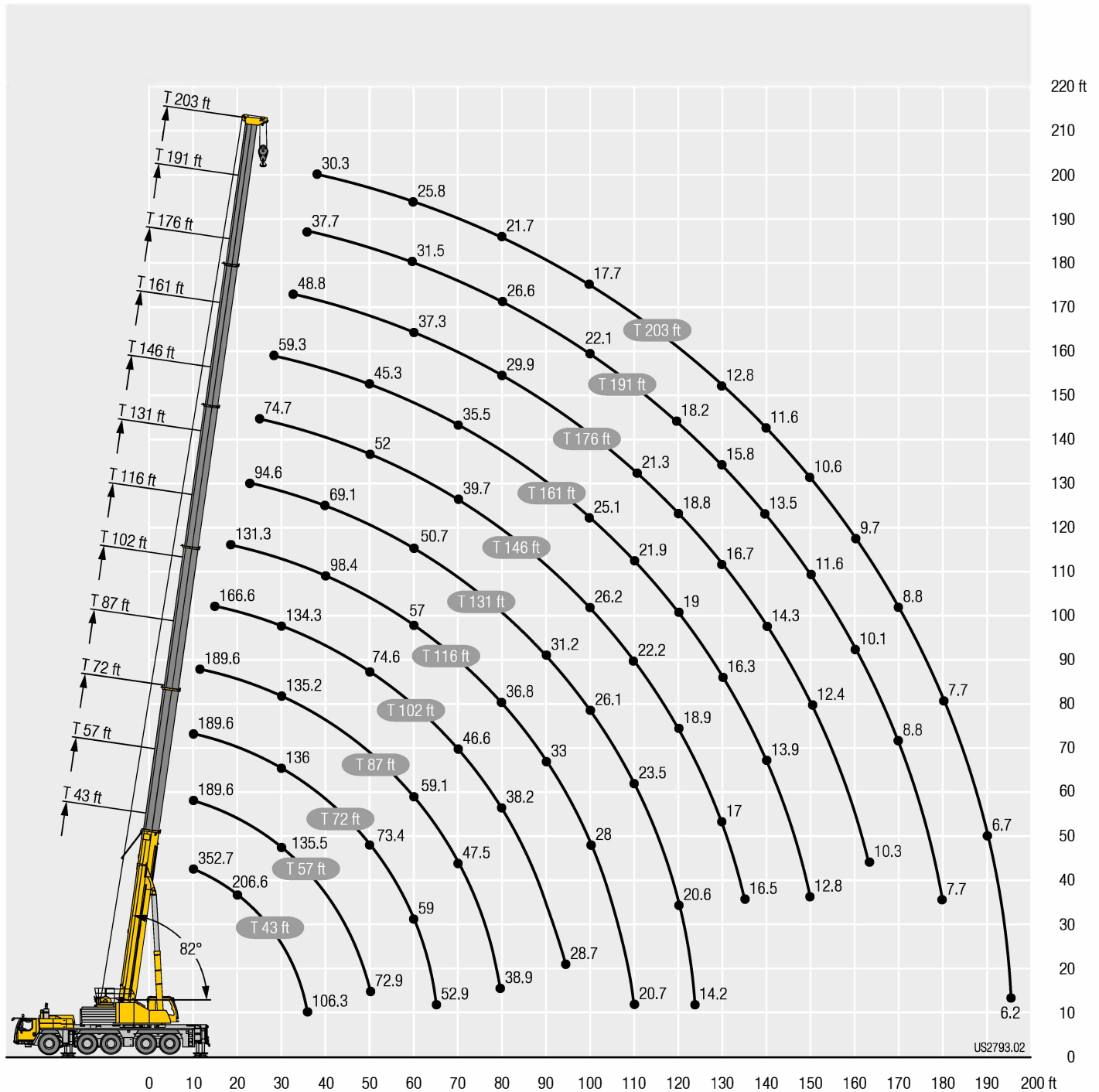

STERLING CRANE



LIFTING CHARTS - All Terrain Cranes

LIEBHERR MODEL LTM 1160-5.2 - 190 TON CAPACITY

Lifting capacities Forces de levage

TNZK

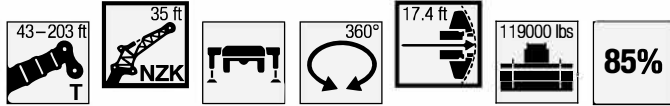

Jib 43-203 ft	43 ft			57 ft			72 ft			87 ft			102 ft			116 ft			Jib 43-203 ft
	35 ft			35 ft			35 ft			35 ft			35 ft			35 ft			
	0°	20°	40°	0°	20°	40°	0°	20°	40°	0°	20°	40°	0°	20°	40°	0°	20°	40°	
17	40.3	34.7		40.3			40.3			40.3			40.3			40.3			17
18	40	33.8		40.3			40.3			40.3			40.3			40.3			18
19	39.3	33		40.3	34.9		40.3			40.3			40.3			40.3			19
20	38.4	32.2		40.3	34.2		40.3			40.3			40.3			40.3			20
22	36.7	30.7		40.1	32.8		40.3	34.5		40.3			40.3			40.3			22
24	35	29.3		39	31.5		40.3	33.3		40.3	34.7		40.3			40.3			24
26	33.4	28.1	24	37.6	30.3		40.2	32.1		40.3	33.7		40.3			40.3			26
28	31.8	27	23.3	36.1	29.2	23.9	39.5	31.1		40.3	32.6		40.3	33.2		40.3			28
30	30.3	25.9	22.5	34.7	28.2	23.3	38.2	30.1	23.8	40.3	31.6		40.3	32.3		39.9	31.2		30
32	29	25	21.9	33.3	27.2	22.7	37	29.1	23.2	39.8	30.7	23.5	40.3	31.5		39.4	30.5		32
34	27.8	24.1	21.3	32.1	26.3	22.1	35.7	28.2	22.7	38.7	29.9	23.1	40.3	30.6		38.7	29.8		34
36	26.6	23.2	20.7	30.8	25.5	21.6	34.5	27.4	22.2	37.6	29	22.6	39.8	29.9	22.8	38.1	29.1		36
38	25.5	22.5	20.1	29.5	24.7	21.1	33.3	26.6	21.7	36.5	28.3	22.2	39	29.1	22.4	37.4	28.5	22	38
40	24.6	21.7	19.6	28.5	24	20.6	32.2	25.9	21.3	35.4	27.6	21.8	38.1	28.4	22	36.7	27.9	21.7	40
45	21.9	20.1	18.5	26.1	22.3	19.6	29.5	24.2	20.3	32.9	25.8	20.8	35.7	26.8	21.1	35	26.4	20.9	45
50	19	18.8	17.6	24	20.9	18.7	27.3	22.8	19.4	30.4	24.4	20	33.3	25.4	20.3	33.1	25.2	20.2	50
55	16.7	17.7	16.9	21.5	19.7	17.9	25.4	21.5	18.7	28.3	23.1	19.3	31.1	24.1	19.7	31.5	24	19.5	55
60	14.8	16.8	16.5	19	18.6	17.3	23.2	20.3	18	26.5	21.9	18.6	29.1	22.9	19	30	23	19	60
65	13.2	15.9	16.3	17.1	17.7	16.7	21	19.3	17.4	24.7	20.9	18	27.4	21.9	18.4	28.5	22	18.4	65
70	12	15.3		15.4	16.9	16.4	19	18.5	16.9	22.4	20	17.5	25.5	21	17.9	26.7	21.1	18	70
75				14	16.3	16.2	17.3	17.7	16.5	20.5	19.1	17	23.5	20.1	17.4	24.8	20.4	17.5	75
80				12.8	15.6		15.8	17.1	16.2	18.8	18.4	16.7	21.6	19.4	17	23.1	19.7	17.1	80
85				11.8			14.6	16.5	16.1	17.3	17.7	16.3	20	18.7	16.7	21.6	19	16.8	85
90							13.4	15.9		16	17.2	16.1	18.5	18.1	16.4	20.1	18.4	16.5	90
95							12.4	15.4		14.9	16.7	16	17.2	17.5	16.1	18.8	17.9	16.2	95
100							11.7			13.9	16.2		16.1	17	16	17.7	17.4	16	100
105										13	15.7		15.1	16.6	15.9	16.6	16.9	15.8	105
110										12.2	15.3		14.2	16.1		15.7	16.6	15.7	110
115										11.6			13.4	15.7		14.9	16.2	15.6	115
120													12.6	15.4		14.1	15.8	15.6	120
125													12.1	15.1		13.4	15.4		125
130													11.5			12.8	15.2		130
135																12.2	15		135
140																11.8	14.3		140
145																11.4			145



LIFTING CHARTS - All Terrain Cranes

LIEBHERR MODEL LTM 1160-5.2 - 190 TON CAPACITY

Lifting capacities Forces de levage

TNZK

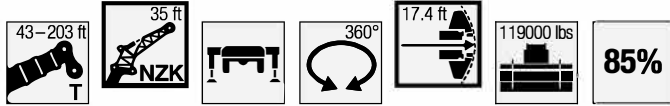

Jib ↙	131 ft			146 ft			161 ft			176 ft			191 ft			203 ft			Jib ↘
	35 ft			35 ft			35 ft			35 ft			35 ft			35 ft			
	0°	20°	40°	0°	20°	40°	0°	20°	40°	0°	20°	40°	0°	20°	40°	0°	20°	40°	
22	39.2																		22
24	38.8																		24
26	38.3			33															26
28	37.9			32.7															28
30	37.5			32.4			28.4												30
32	37.1			32.1			28.2			24.2									32
34	36.6	29.3		31.8			27.9			24.1									34
36	36.1	28.7		31.5			27.7			24			20.1						36
38	35.4	28.2		31.2	26.5		27.5			23.9			20.1			15.9			38
40	34.8	27.6		30.8	26.1		27.3			23.7			20			15.9			40
45	33.3	26.3	20.8	29.8	25		26.7	23.7		23.4			19.9			15.8			45
50	31.9	25.1	20.2	28.8	24	20	26	22.9	19.7	23.1	21.5		19.7	18.7		15.8			50
55	30.6	24.1	19.5	27.8	23.1	19.5	25.4	22.2	19.2	22.7	20.9	18.3	19.5	18.4		15.7	15.8		55
60	29.3	23.1	19	26.9	22.3	19	24.7	21.5	18.7	22.2	20.3	18	19.3	18.2	16.8	15.7	15.3		60
65	28	22.2	18.5	26.1	21.5	18.6	24	20.8	18.3	21.7	19.8	17.6	19	17.8	16.5	15.2	14.8	14.6	65
70	26.9	21.4	18	25.2	20.8	18.1	23.4	20.2	17.9	21.3	19.3	17.2	18.7	17.4	16.2	14.8	14.3	14.2	70
75	25.7	20.6	17.6	24.4	20.2	17.7	22.8	19.6	17.5	20.9	18.8	16.9	18.3	16.9	16	14.3	13.9	13.7	75
80	24.4	19.9	17.2	23.6	19.5	17.4	22.2	19.1	17.2	20.4	18.4	16.6	17.8	16.4	15.7	13.9	13.4	13.3	80
85	23	19.3	16.9	22.7	19	17.1	21.6	18.6	16.9	20	17.9	16.4	17.3	15.9	15.5	13.5	13	12.9	85
90	21.6	18.7	16.6	21.7	18.5	16.8	21	18.1	16.6	19.6	17.5	16.1	16.8	15.4	15.2	13.1	12.6	12.5	90
95	20.4	18.2	16.3	20.7	18	16.5	20.4	17.7	16.4	19.1	17.2	15.9	16.2	14.9	14.8	12.7	12.2	12.1	95
100	19.2	17.7	16.1	19.7	17.6	16.3	19.7	17.3	16.1	18.6	16.8	15.7	15.7	14.5	14.3	12.3	11.9	11.8	100
105	18.1	17.3	15.9	18.7	17.2	16.1	18.9	16.9	16	18.1	16.5	15.5	15.2	14.1	13.9	11.9	11.5	11.5	105
110	17.2	16.9	15.7	17.8	16.8	15.9	18.2	16.6	15.8	17.3	16.2	15.4	14.7	13.7	13.5	11.5	11.2	11.2	110
115	16.3	16.5	15.6	17	16.5	15.8	17.5	16.3	15.6	16.5	15.9	15.3	14.2	13.3	13.2	11.2	10.9	10.9	115
120	15.5	16.2	15.5	16.2	16.1	15.7	16.7	16	15.5	15.8	15.5	15.1	13.8	12.9	12.8	10.9	10.7	10.6	120
125	14.7	15.9	15.4	15.5	15.9	15.6	16	15.7	15.4	15	15	15	13.3	12.5	12.5	10.5	10.4	10.4	125
130	14.1	15.4	15.4	14.8	15.6	15.4	15	15.4	15.3	14.3	14.5	14.6	12.9	12.2	12.1	10	10.1	10.1	130
135	13.4	15		14.1	15.1	15.1	14.1	14.5	14.9	13.6	13.9	14.1	12.4	11.9	11.9	9.6	9.8	9.9	135
140	12.7	14.5		13.6	14.4	14.7	13.4	13.5	13.9	12.6	13.1	13.4	11.9	11.5	11.6	9.2	9.4	9.6	140
145	12.3	13.9		12.8	13.3		12.7	13	13	11.7	12.3	12.7	11.3	11.2	11.3	8.8	9	9.2	145
150	11.9	13		12	12.3		11.8	12.2	12.5	11	11.4	11.8	10.9	10.9	11.1	8.4	8.6	8.8	150
155	11.5			11.2	11.5		11	11.4	11.7	10.6	10.7	11	10.2	10.6	10.8	8	8.2	8.4	155
160	8.6			10.6	10.8		10.3	10.7		10.3	10.4	10.4	9.6	10.1	10.4	7.6	7.9	8	160
165				10.3	10.3		9.7	9.9		9.8	10	10.1	8.9	9.5	9.7	7.3	7.5	7.7	165
170				9.8			9.1	9.3		9.1	9.5		8.3	8.8	9	6.9	7.1	7.3	170
175				4.8			8.6	8.7		8.6	8.9		7.7	8.2	8.4	6.6	6.8	6.9	175
180							8.3	8.4		8	8.3		7.1	7.6		6.3	6.5	6.6	180
185							8.1			7.5	7.7		6.6	7		6	6.2	6.3	185
190										7	7.2		6.1	6.5		5.7	5.9		190
195										6.6	6.7		5.7	6		5.4	5.6		195
200										6.2			5.2	5.5		4.6	5.3		200
205													4.8	5.1		3.5	4.4		205
210													4.5	4.7		2.2	3.1		210
215													3.5						215

STERLING CRANE



LIFTING CHARTS - All Terrain Cranes

LIEBHERR MODEL LTM 1160-5.2 - 190 TON CAPACITY

Lifting capacities Forces de levage

TNZK

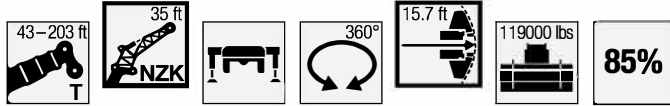

Jib 17 18 19 20 22 24 26 28 30 32 34 36 38 40 45 50 55 60 65 70 75 80 85 90 95 100 105 110 115 120 125 130 135 140 145	43 ft 35 ft			57 ft 35 ft			72 ft 35 ft			87 ft 35 ft			102 ft 35 ft			116 ft 35 ft			Jib 17 18 19 20 22 24 26 28 30 32 34 36 38 40 45 50 55 60 65 70 75 80 85 90 95 100 105 110 115 120 125 130 135 140 145
	0°	20°	40°	0°	20°	40°	0°	20°	40°	0°	20°	40°	0°	20°	40°	0°	20°	40°	
17	40.3	34.7		40.3			40.3			40.3			40.3			40.3			17
18	40	33.8		40.3			40.3			40.3			40.3			40.3			18
19	39.3	33		40.3	34.9		40.3			40.3			40.3			40.3			19
20	38.4	32.2		40.3	34.2		40.3			40.3			40.3			40.3			20
22	36.7	30.7		40.1	32.8		40.3	34.5		40.3			40.3			40.3			22
24	35	29.3		39	31.5		40.3	33.3		40.3	34.7		40.3			40.3			24
26	33.4	28.1	24	37.6	30.3		40.2	32.1		40.3	33.7		40.3			40.3			26
28	31.8	27	23.3	36.1	29.2	23.9	39.5	31.1		40.3	32.6		40.3	33.2		40.3			28
30	30.3	25.9	22.5	34.7	28.2	23.3	38.2	30.1	23.8	40.3	31.6		40.3	32.3		39.9	31.2		30
32	29	25	21.9	33.3	27.2	22.7	37	29.1	23.2	39.8	30.7	23.5	40.3	31.5		39.4	30.5		32
34	27.8	24.1	21.3	32.1	26.3	22.1	35.7	28.2	22.7	38.7	29.9	23.1	40.3	30.6		38.7	29.8		34
36	26.6	23.2	20.7	30.8	25.5	21.6	34.5	27.4	22.2	37.6	29	22.6	39.8	29.9	22.8	38.1	29.1		36
38	25.5	22.5	20.1	29.5	24.7	21.1	33.3	26.6	21.7	36.5	28.3	22.2	39	29.1	22.4	37.4	28.5	22	38
40	24.6	21.7	19.6	28.5	24	20.6	32.2	25.9	21.3	35.4	27.6	21.8	38.1	28.4	22	36.7	27.9	21.7	40
45	21.9	20.1	18.5	26.1	22.3	19.6	29.5	24.2	20.3	32.9	25.8	20.8	35.7	26.8	21.1	35	26.4	20.9	45
50	19	18.8	17.6	24	20.9	18.7	27.3	22.8	19.4	30.4	24.4	20	33.3	25.4	20.3	33.1	25.2	20.2	50
55	16.7	17.7	16.9	21.5	19.7	17.9	25.4	21.5	18.7	28.3	23.1	19.3	31.1	24.1	19.7	31.5	24	19.5	55
60	14.8	16.8	16.5	19	18.6	17.3	23.2	20.3	18	26.5	21.9	18.6	29.1	22.9	19	30	23	19	60
65	13.2	15.9	16.3	17.1	17.7	16.7	21	19.3	17.4	24.7	20.9	18	27.4	21.9	18.4	28.5	22	18.4	65
70	12	15.3		15.4	16.9	16.4	19	18.5	16.9	22.4	20	17.5	25.5	21	17.9	26.7	21.1	18	70
75				14	16.3	16.2	17.3	17.7	16.5	20.5	19.1	17	23.5	20.1	17.4	24.8	20.4	17.5	75
80				12.8	15.6		15.8	17.1	16.2	18.8	18.4	16.7	21.6	19.4	17	23.1	19.7	17.1	80
85				11.8			14.6	16.5	16.1	17.3	17.7	16.3	20	18.7	16.7	21.6	19	16.8	85
90							13.4	15.9		16	17.2	16.1	18.5	18.1	16.4	20.1	18.4	16.5	90
95							12.4	15.4		14.9	16.7	16	17.2	17.5	16.1	18.8	17.9	16.2	95
100							11.7			13.9	16.2		16.1	17	16	17.7	17.4	16	100
105										13	15.7		15.1	16.6	15.9	16.6	16.9	15.8	105
110										12.2	15.3		14.2	16.1		15.7	16.6	15.7	110
115										11.6			13.4	15.7		14.9	16.2	15.6	115
120													12.6	15.4		14.1	15.8	15.6	120
125													12.1	15.1		13.4	15.4		125
130													11.5			12.8	15.2		130
135																12.2	14.4		135
140																11.8	14.1		140
145																11.4			145



LIFTING CHARTS - All Terrain Cranes

LIEBHERR MODEL LTM 1160-5.2 - 190 TON CAPACITY

Lifting capacities Forces de levage

TNZK

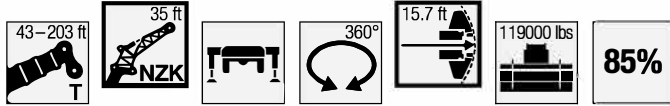

Jib	131 ft			146 ft			161 ft			176 ft			191 ft			203 ft			Jib
	35 ft			35 ft			35 ft			35 ft			35 ft			35 ft			
	0°	20°	40°	0°	20°	40°	0°	20°	40°	0°	20°	40°	0°	20°	40°	0°	20°	40°	
22	39.2																		22
24	38.8																		24
26	38.3			33															26
28	37.9			32.7															28
30	37.5			32.4			28.4												30
32	37.1			32.1			28.2			24.2									32
34	36.6	29.3		31.8			27.9			24.1									34
36	36.1	28.7		31.5			27.7			24			20.1						36
38	35.4	28.2		31.2	26.5		27.5			23.9			20.1			15.9			38
40	34.8	27.6		30.8	26.1		27.3			23.7			20			15.9			40
45	33.3	26.3	20.8	29.8	25		26.7	23.7		23.4			19.9			15.8			45
50	31.9	25.1	20.2	28.8	24	20	26	22.9	19.7	23.1	21.5		19.7	18.7		15.8			50
55	30.6	24.1	19.5	27.8	23.1	19.5	25.4	22.2	19.2	22.7	20.9	18.3	19.5	18.4		15.7	15.8		55
60	29.3	23.1	19	26.9	22.3	19	24.7	21.5	18.7	22.2	20.3	18	19.3	18.2	16.8	15.7	15.3		60
65	28	22.2	18.5	26.1	21.5	18.6	24	20.8	18.3	21.7	19.8	17.6	19	17.8	16.5	15.2	14.8	14.6	65
70	26.9	21.4	18	25.2	20.8	18.1	23.4	20.2	17.9	21.3	19.3	17.2	18.7	17.4	16.2	14.8	14.3	14.2	70
75	25.7	20.6	17.6	24.4	20.2	17.7	22.8	19.6	17.5	20.9	18.8	16.9	18.3	16.9	16	14.3	13.9	13.7	75
80	24.4	19.9	17.2	23.6	19.5	17.4	22.2	19.1	17.2	20.4	18.4	16.6	17.8	16.4	15.7	13.9	13.4	13.3	80
85	23	19.3	16.9	22.7	19	17.1	21.6	18.6	16.9	20	17.9	16.4	17.3	15.9	15.5	13.5	13	12.9	85
90	21.6	18.7	16.6	21.7	18.5	16.8	21	18.1	16.6	19.6	17.5	16.1	16.8	15.4	15.2	13.1	12.6	12.5	90
95	20.4	18.2	16.3	20.7	18	16.5	20.4	17.7	16.4	19.1	17.2	15.9	16.2	14.9	14.8	12.7	12.2	12.1	95
100	19.2	17.7	16.1	19.7	17.6	16.3	19.7	17.3	16.1	18.6	16.8	15.7	15.7	14.5	14.3	12.3	11.9	11.8	100
105	18.1	17.3	15.9	18.7	17.2	16.1	18.9	16.9	16	18.1	16.5	15.5	15.2	14.1	13.9	11.9	11.5	11.5	105
110	17.2	16.9	15.7	17.8	16.8	15.9	18.2	16.6	15.8	17.3	16.2	15.4	14.7	13.7	13.5	11.5	11.2	11.2	110
115	16.3	16.5	15.6	17	16.5	15.8	17.4	16.3	15.6	16.5	15.9	15.3	14.2	13.3	13.2	11.2	10.9	10.9	115
120	15.5	16.2	15.5	16.2	16.1	15.7	16.5	16	15.5	15.8	15.5	15.1	13.8	12.9	12.8	10.9	10.7	10.6	120
125	14.7	15.7	15.4	15.3	15.7	15.6	15.3	15.6	15.4	14.9	15	15	13.3	12.5	12.5	10.5	10.4	10.4	125
130	13.8	15.3	15.3	14.7	15.4	15.4	14.7	14.7	15	13.7	14.4	14.6	12.9	12.2	12.1	10	10.1	10.1	130
135	13.3	14.7		13.8	14.4	14.9	13.7	14.1	14.2	12.6	13.3	13.9	12.4	11.9	11.9	9.6	9.8	9.9	135
140	12.7	14.1		12.8	13.3	13.7	12.6	13.2	13.6	11.9	12.3	12.8	11.8	11.5	11.6	9.2	9.4	9.6	140
145	12.2	13.1		12	12.3		11.7	12.2	12.6	11.5	11.5	11.9	11	11.2	11.3	8.8	9	9.2	145
150	11.8	12.6		11.5	11.6		10.9	11.4	11.7	11	11.1	11.1	10.2	10.8	11.1	8.4	8.6	8.8	150
155	11.5			10.9	11.1		10.2	10.6	10.9	10.3	10.7	10.8	9.4	10.1	10.4	8	8.2	8.4	155
160	8.6			10.2	10.5		9.6	9.8		9.6	10	10.4	8.8	9.4	9.7	7.6	7.9	8	160
165				9.9	9.9		9.2	9.4		9	9.3	9.7	8.1	8.7	9	7.3	7.5	7.7	165
170				9.6			8.9	9		8.4	8.7		7.5	8.1	8.3	6.9	7.1	7.3	170
175				4.8			8.5	8.7		7.8	8.1		6.9	7.5	7.6	6.6	6.8	6.9	175
180							8	8.1		7.3	7.5		6.4	6.9		6.3	6.5	6.6	180
185							7.5			6.8	7		5.9	6.3		5.9	6.2	6.3	185
190										6.4	6.5		5.4	5.8		5.4	5.8		190
195										5.9	6		5	5.4		5	5.3		195
200										5.5			4.6	4.9		4.1	4.8		200
205													4.2	4.5		3	3.9		205
210													3.9	4			2.6		210
215													3						215

STERLING CRANE



LIFTING CHARTS - All Terrain Cranes

LIEBHERR MODEL LTM 1160-5.2 - 190 TON CAPACITY

Lifting capacities Forces de levage

TNZK

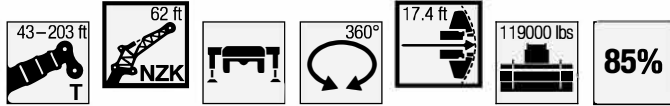

Jib 17 18 19 20 22 24 26 28 30 32 34 36 38 40 45 50 55 60 65 70 75 80 85 90 95 100 105 110 115 120 125 130 135 140 145 150 155 160 165 170	43 ft 62 ft			57 ft 62 ft			72 ft 62 ft			87 ft 62 ft			102 ft 62 ft			116 ft 62 ft			Jib 17 18 19 20 22 24 26 28 30 32 34 36 38 40 45 50 55 60 65 70 75 80 85 90 95 100 105 110 115 120 125 130 135 140 145 150 155 160 165 170
	0°	20°	40°	0°	20°	40°	0°	20°	40°	0°	20°	40°	0°	20°	40°	0°	20°	40°	
17	16.3			16.4			16.4			16.5									17
18	16.2			16.3			16.4			16.5									18
19	16.2			16.3			16.4			16.4			16.5						19
20	16.1			16.3			16.3			16.4			16.5						20
22	15.9			16.2			16.3			16.4			16.4			16.1			22
24	15.7			16			16.3			16.3			16.4			16			24
26	15.5			15.9			16.2			16.3			16.3			15.8			26
28	15.1			15.7			16			16.2			16.3			15.7			28
30	14.8			15.5			15.9			16.1			16.2			15.6			30
32	14.4	12.3		15.3			15.7			16			16.1			15.4			32
34	14	12		14.9	12.3		15.5			15.9			15.9			15.3			34
36	13.6	11.7		14.6	12		15.3	12.2		15.7			15.7			15.1			36
38	13.2	11.4		14.3	11.7		15.1	12		15.4	12.2		15.5			14.9			38
40	12.9	11.1		13.9	11.5		14.8	11.7		15.2	11.9		15.2			14.8			40
45	12	10.5		13.1	10.9		14	11.2		14.5	11.4		14.7	11.5		14.3	11.4		45
50	11.3	9.9	8.6	12.3	10.4	8.8	13.3	10.7		13.9	10.9		14.1	11.1		13.8	11		50
55	10.6	9.5	8.3	11.7	9.9	8.5	12.6	10.2	8.6	13.2	10.5	8.7	13.5	10.7		13.3	10.7		55
60	9.8	9	8.1	11.1	9.5	8.3	11.9	9.8	8.4	12.6	10.1	8.4	12.9	10.3	8.5	12.8	10.3	8.5	60
65	9	8.6	7.9	10.4	9.1	8.1	11.4	9.4	8.2	12	9.7	8.3	12.4	10	8.3	12.3	10	8.3	65
70	8.3	8.3	7.7	9.6	8.8	7.9	10.7	9.1	8	11.5	9.4	8.1	11.9	9.6	8.2	11.9	9.7	8.2	70
75	7.6	8	7.5	8.9	8.5	7.7	10.1	8.8	7.8	10.9	9.1	7.9	11.4	9.4	8	11.5	9.4	8	75
80	7.1	7.8	7.5	8.3	8.2	7.6	9.5	8.5	7.7	10.4	8.8	7.8	11	9.1	7.9	11.1	9.2	7.9	80
85	6.6	7.6	7.5	7.7	8	7.5	8.8	8.3	7.6	9.8	8.6	7.7	10.6	8.8	7.8	10.8	8.9	7.8	85
90	6.2	7.5	7.5	7.2	7.8	7.5	8.3	8.1	7.5	9.3	8.4	7.6	10.1	8.6	7.7	10.4	8.7	7.7	90
95	5.8	7.5		6.8	7.6	7.4	7.8	7.9	7.4	8.7	8.2	7.5	9.5	8.4	7.6	10	8.5	7.6	95
100				6.4	7.5	7.4	7.3	7.7	7.4	8.2	8	7.4	9	8.2	7.5	9.6	8.4	7.5	100
105				6	7.4		6.9	7.6	7.4	7.8	7.8	7.4	8.6	8.1	7.4	9.1	8.2	7.5	105
110				5.7	7.4		6.6	7.5	7.4	7.4	7.7	7.4	8.1	7.9	7.4	8.7	8	7.4	110
115							6.2	7.4	7.4	7	7.6	7.4	7.7	7.8	7.4	8.3	7.9	7.4	115
120							5.9	7.4		6.7	7.5	7.4	7.4	7.7	7.4	7.9	7.8	7.4	120
125							5.7	7.4		6.4	7.4	7.4	7	7.5	7.4	7.6	7.7	7.3	125
130										6.1	7.4		6.7	7.5	7.4	7.3	7.6	7.3	130
135										5.9	7.4		6.5	7.4	7.4	7	7.5	7.3	135
140										5.6	7.4		6.2	7.4	7.4	6.7	7.4	7.3	140
145													6	7.4		6.5	7.3	7.3	145
150													5.8	7.4		6.2	7.3	7.3	150
155													5.6	7.4		6	7.3		155
160																5.8	7.3		160
165																5.7	7.3		165
170																5.5			170



LIFTING CHARTS - All Terrain Cranes

LIEBHERR MODEL LTM 1160-5.2 - 190 TON CAPACITY

Lifting capacities Forces de levage

TNZK

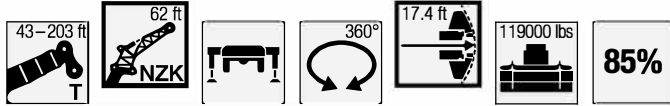

Lift Height (ft)	131 ft 62 ft			146 ft 62 ft			161 ft 62 ft			176 ft 62 ft			191 ft 62 ft			203 ft 62 ft			Lift Height (ft)
	0°	20°	40°	0°	20°	40°	0°	20°	40°	0°	20°	40°	0°	20°	40°	0°	20°	40°	
26	15.4																		26
28	15.2			14.1															28
30	15.1			14															30
32	15			13.9			13												32
34	14.9			13.8			12.9												34
36	14.7			13.7			12.8			11.8									36
38	14.6			13.6			12.7			11.8									38
40	14.4			13.5			12.7			11.7			10.6						40
45	14			13.3			12.5			11.6			10.5			9.5			45
50	13.6	11		12.9			12.3			11.5			10.4			9.4			50
55	13.2	10.7		12.6	10.5		12	10.2		11.3			10.3			9.4			55
60	12.7	10.4		12.2	10.2		11.7	10		11.1	9.7		10.2			9.3			60
65	12.3	10.1	8.3	11.9	9.9		11.4	9.7		10.9	9.5		10	9.1		9.2			65
70	11.9	9.8	8.2	11.5	9.7	8.1	11.2	9.5		10.7	9.3		9.9	8.9		9.1	8.5		70
75	11.5	9.5	8.1	11.2	9.4	8	10.9	9.3	8	10.5	9.1	7.9	9.7	8.8		9	8.4		75
80	11.2	9.3	7.9	10.9	9.2	7.9	10.7	9.1	7.9	10.3	8.9	7.8	9.6	8.6		8.9	8.2		80
85	10.8	9.1	7.8	10.6	9	7.8	10.4	8.9	7.8	10.1	8.8	7.7	9.5	8.5	7.6	8.7	8.1		85
90	10.5	8.8	7.7	10.4	8.8	7.7	10.2	8.8	7.7	9.9	8.6	7.6	9.3	8.4	7.5	8.6	8	7.3	90
95	10.2	8.7	7.6	10.1	8.7	7.6	10	8.6	7.6	9.7	8.5	7.5	9.2	8.2	7.4	8.5	7.9	7.3	95
100	10	8.5	7.6	9.9	8.5	7.5	9.7	8.4	7.5	9.5	8.3	7.5	9	8.1	7.4	8.4	7.8	7.2	100
105	9.6	8.3	7.5	9.6	8.3	7.5	9.5	8.3	7.5	9.3	8.2	7.4	8.9	8	7.3	8.3	7.7	7.2	105
110	9.2	8.2	7.4	9.4	8.2	7.4	9.3	8.2	7.4	9.1	8.1	7.4	8.7	7.9	7.3	8.2	7.6	7.1	110
115	8.8	8	7.4	9.1	8	7.4	9.1	8	7.4	8.9	8	7.3	8.6	7.8	7.2	8.1	7.6	7.1	115
120	8.4	7.9	7.3	8.8	7.9	7.3	8.9	7.9	7.3	8.7	7.9	7.3	8.5	7.7	7.2	8	7.5	7.1	120
125	8.1	7.8	7.3	8.4	7.8	7.3	8.6	7.8	7.3	8.6	7.8	7.2	8.4	7.6	7.2	7.9	7.4	7	125
130	7.8	7.7	7.3	8.1	7.7	7.3	8.4	7.7	7.3	8.4	7.7	7.2	8.2	7.5	7.1	7.8	7.4	7	130
135	7.5	7.6	7.3	7.8	7.6	7.3	8.1	7.6	7.2	8.2	7.6	7.2	8	7.5	7.1	7.8	7.3	7	135
140	7.2	7.5	7.3	7.5	7.5	7.3	7.8	7.6	7.2	8	7.5	7.2	7.8	7.4	7.1	7.6	7.2	7	140
145	6.9	7.4	7.3	7.3	7.4	7.3	7.5	7.5	7.2	7.7	7.5	7.1	7.7	7.3	7.1	7.5	7.2	7	145
150	6.7	7.4	7.3	7	7.4	7.3	7.3	7.4	7.2	7.5	7.4	7.1	7.5	7.3	7.1	7.4	7.1	7	150
155	6.5	7.3	7.3	6.8	7.3	7.3	7.1	7.4	7.2	7.3	7.3	7.1	7.3	7.2	7.1	7.2	7.1	7	155
160	6.3	7.3	7.3	6.6	7.3	7.3	6.9	7.3	7.2	7.1	7.3	7.1	7.1	7.2	7.1	7	7	6.9	160
165	6.1	7.3	7.3	6.4	7.3	7.3	6.7	7.3	7.2	6.9	7.2	7.1	7	7.1	7.1	6.8	6.8	6.9	165
170	5.9	7.3		6.2	7.3	7.3	6.5	7.2	7.2	6.7	7.2	7.1	6.8	7.1	7.1	6.5	6.7	6.8	170
175	5.8	7.3		6.1	7.3	7.3	6.3	7.2	7.2	6.5	7.2	7.1	6.6	7.1	7.1	6.3	6.5	6.7	175
180	5.6	7.3		5.9	7.3		6.2	7.2	7.2	6.4	7.2	7.1	6.5	7.1	7.1	6	6.3	6.5	180
185	5.5			5.8	7.3		6	7.2	7.2	6.3	7.1	7.1	6.3	7.1	7.1	5.7	6	6.3	185
190				5.7	7.3		5.9	7.2		6.1	7.1	7.1	6.2	7.1	7.1	5.5	5.8	6.1	190
195				5.6	7.3		5.8	7.2		6	7.1	7.1	6.1	6.9	7.1	5.2	5.5	5.8	195
200				5.5			5.7	7.1		5.8	7.1	7.1	5.9	6.5	6.8	5	5.3	5.5	200
205							5.6	6.6		5.7	6.8		5.5	6.1	6.3	4.5	5	5.2	205
210							5.5	6.4		5.6	6.3		5.2	5.6	5.8	3.5	4.7	4.9	210
215							5.3			5.5	5.9		4.5	5.2		2.3	4.2	4.6	215
220										5.3	5.5		3.6	4.8			2.9	3.5	220
225										5	5.1		2.5	3.6				2.2	225
230										3.4				2.5					230

STERLING CRANE



LIFTING CHARTS - All Terrain Cranes

LIEBHERR MODEL LTM 1160-5.2 - 190 TON CAPACITY

Lifting capacities Forces de levage

TNZK

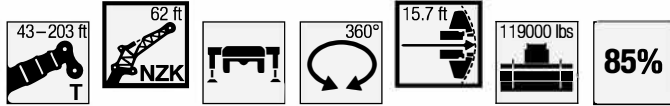

Jib 17 18 19 20 22 24 26 28 30 32 34 36 38 40 45 50 55 60 65 70 75 80 85 90 95 100 105 110 115 120 125 130 135 140 145 150 155 160 165 170	43 ft 62 ft			57 ft 62 ft			72 ft 62 ft			87 ft 62 ft			102 ft 62 ft			116 ft 62 ft			Jib 17 18 19 20 22 24 26 28 30 32 34 36 38 40 45 50 55 60 65 70 75 80 85 90 95 100 105 110 115 120 125 130 135 140 145 150 155 160 165 170
	0°	20°	40°	0°	20°	40°	0°	20°	40°	0°	20°	40°	0°	20°	40°	0°	20°	40°	
17	16.3			16.4			16.4			16.5									17
18	16.2			16.3			16.4			16.5									18
19	16.2			16.3			16.4			16.4			16.5						19
20	16.1			16.3			16.3			16.4			16.5						20
22	15.9			16.2			16.3			16.4			16.4			16.1			22
24	15.7			16			16.3			16.3			16.4			16			24
26	15.5			15.9			16.2			16.3			16.3			15.8			26
28	15.1			15.7			16			16.2			16.3			15.7			28
30	14.8			15.5			15.9			16.1			16.2			15.6			30
32	14.4	12.3		15.3			15.7			16			16.1			15.4			32
34	14	12		14.9	12.3		15.5			15.9			15.9			15.3			34
36	13.6	11.7		14.6	12		15.3	12.2		15.7			15.7			15.1			36
38	13.2	11.4		14.3	11.7		15.1	12		15.4	12.2		15.5			14.9			38
40	12.9	11.1		13.9	11.5		14.8	11.7		15.2	11.9		15.2			14.8			40
45	12	10.5		13.1	10.9		14	11.2		14.5	11.4		14.7	11.5		14.3	11.4		45
50	11.3	9.9	8.6	12.3	10.4	8.8	13.3	10.7		13.9	10.9		14.1	11.1		13.8	11		50
55	10.6	9.5	8.3	11.7	9.9	8.5	12.6	10.2	8.6	13.2	10.5	8.7	13.5	10.7		13.3	10.7		55
60	9.8	9	8.1	11.1	9.5	8.3	11.9	9.8	8.4	12.6	10.1	8.4	12.9	10.3	8.5	12.8	10.3	8.5	60
65	9	8.6	7.9	10.4	9.1	8.1	11.4	9.4	8.2	12	9.7	8.3	12.4	10	8.3	12.3	10	8.3	65
70	8.3	8.3	7.7	9.6	8.8	7.9	10.7	9.1	8	11.5	9.4	8.1	11.9	9.6	8.2	11.9	9.7	8.2	70
75	7.6	8	7.5	8.9	8.5	7.7	10.1	8.8	7.8	10.9	9.1	7.9	11.4	9.4	8	11.5	9.4	8	75
80	7.1	7.8	7.5	8.3	8.2	7.6	9.5	8.5	7.7	10.4	8.8	7.8	11	9.1	7.9	11.1	9.2	7.9	80
85	6.6	7.6	7.5	7.7	8	7.5	8.8	8.3	7.6	9.8	8.6	7.7	10.6	8.8	7.8	10.8	8.9	7.8	85
90	6.2	7.5	7.5	7.2	7.8	7.5	8.3	8.1	7.5	9.3	8.4	7.6	10.1	8.6	7.7	10.4	8.7	7.7	90
95	5.8	7.5		6.8	7.6	7.4	7.8	7.9	7.4	8.7	8.2	7.5	9.5	8.4	7.6	10	8.5	7.6	95
100				6.4	7.5	7.4	7.3	7.7	7.4	8.2	8	7.4	9	8.2	7.5	9.6	8.4	7.5	100
105				6	7.4		6.9	7.6	7.4	7.8	7.8	7.4	8.6	8.1	7.4	9.1	8.2	7.5	105
110				5.7	7.4		6.6	7.5	7.4	7.4	7.7	7.4	8.1	7.9	7.4	8.7	8	7.4	110
115							6.2	7.4	7.4	7	7.6	7.4	7.7	7.8	7.4	8.3	7.9	7.4	115
120							5.9	7.4		6.7	7.5	7.4	7.4	7.7	7.4	7.9	7.8	7.4	120
125							5.7	7.4		6.4	7.4	7.4	7	7.5	7.4	7.6	7.7	7.3	125
130										6.1	7.4		6.7	7.5	7.4	7.3	7.6	7.3	130
135										5.9	7.4		6.5	7.4	7.4	7	7.5	7.3	135
140										5.6	7.4		6.2	7.4	7.4	6.7	7.4	7.3	140
145													6	7.4		6.5	7.3	7.3	145
150													5.8	7.4		6.2	7.3	7.3	150
155													5.6	7.4		6	7.3		155
160																5.8	7.3		160
165																5.7	7.3		165
170																5.5			170



LIFTING CHARTS - All Terrain Cranes

LIEBHERR MODEL LTM 1160-5.2 - 190 TON CAPACITY

Lifting capacities Forces de levage

TNZK

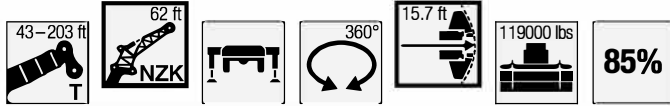

Jib ↙ ↘	131 ft 62 ft			146 ft 62 ft			161 ft 62 ft			176 ft 62 ft			191 ft 62 ft			203 ft 62 ft			Jib ↙ ↘
	0°	20°	40°	0°	20°	40°	0°	20°	40°	0°	20°	40°	0°	20°	40°	0°	20°	40°	
26	15.4																		26
28	15.2			14.1															28
30	15.1			14															30
32	15			13.9			13												32
34	14.9			13.8			12.9												34
36	14.7			13.7			12.8			11.8									36
38	14.6			13.6			12.7			11.8									38
40	14.4			13.5			12.7			11.7			10.6						40
45	14			13.3			12.5			11.6			10.5			9.5			45
50	13.6	11		12.9			12.3			11.5			10.4			9.4			50
55	13.2	10.7		12.6	10.5		12	10.2		11.3			10.3			9.4			55
60	12.7	10.4		12.2	10.2		11.7	10		11.1	9.7		10.2			9.3			60
65	12.3	10.1	8.3	11.9	9.9		11.4	9.7		10.9	9.5		10	9.1		9.2			65
70	11.9	9.8	8.2	11.5	9.7	8.1	11.2	9.5		10.7	9.3		9.9	8.9		9.1	8.5		70
75	11.5	9.5	8.1	11.2	9.4	8	10.9	9.3	8	10.5	9.1	7.9	9.7	8.8		9	8.4		75
80	11.2	9.3	7.9	10.9	9.2	7.9	10.7	9.1	7.9	10.3	8.9	7.8	9.6	8.6		8.9	8.2		80
85	10.8	9.1	7.8	10.6	9	7.8	10.4	8.9	7.8	10.1	8.8	7.7	9.5	8.5	7.6	8.7	8.1		85
90	10.5	8.8	7.7	10.4	8.8	7.7	10.2	8.8	7.7	9.9	8.6	7.6	9.3	8.4	7.5	8.6	8	7.3	90
95	10.2	8.7	7.6	10.1	8.7	7.6	10	8.6	7.6	9.7	8.5	7.5	9.2	8.2	7.4	8.5	7.9	7.3	95
100	10	8.5	7.6	9.9	8.5	7.5	9.7	8.4	7.5	9.5	8.3	7.5	9	8.1	7.4	8.4	7.8	7.2	100
105	9.6	8.3	7.5	9.6	8.3	7.5	9.5	8.3	7.5	9.3	8.2	7.4	8.9	8	7.3	8.3	7.7	7.2	105
110	9.2	8.2	7.4	9.4	8.2	7.4	9.3	8.2	7.4	9.1	8.1	7.4	8.7	7.9	7.3	8.2	7.6	7.1	110
115	8.8	8	7.4	9.1	8	7.4	9.1	8	7.4	8.9	8	7.3	8.6	7.8	7.2	8.1	7.6	7.1	115
120	8.4	7.9	7.3	8.8	7.9	7.3	8.9	7.9	7.3	8.7	7.9	7.3	8.5	7.7	7.2	8	7.5	7.1	120
125	8.1	7.8	7.3	8.4	7.8	7.3	8.6	7.8	7.3	8.6	7.8	7.2	8.4	7.6	7.2	7.9	7.4	7	125
130	7.8	7.7	7.3	8.1	7.7	7.3	8.4	7.7	7.3	8.4	7.7	7.2	8.2	7.5	7.1	7.8	7.4	7	130
135	7.5	7.6	7.3	7.8	7.6	7.3	8.1	7.6	7.2	8.2	7.6	7.2	8	7.5	7.1	7.8	7.3	7	135
140	7.2	7.5	7.3	7.5	7.5	7.3	7.8	7.6	7.2	8	7.5	7.2	7.8	7.4	7.1	7.6	7.2	7	140
145	6.9	7.4	7.3	7.3	7.4	7.3	7.5	7.5	7.2	7.7	7.5	7.1	7.7	7.3	7.1	7.5	7.2	7	145
150	6.7	7.4	7.3	7	7.4	7.3	7.3	7.4	7.2	7.5	7.4	7.1	7.5	7.3	7.1	7.4	7.1	7	150
155	6.5	7.3	7.3	6.8	7.3	7.3	7.1	7.4	7.2	7.3	7.3	7.1	7.3	7.2	7.1	7.2	7.1	7	155
160	6.3	7.3	7.3	6.6	7.3	7.3	6.9	7.3	7.2	7.1	7.3	7.1	7.1	7.2	7.1	7	7	6.9	160
165	6.1	7.3	7.3	6.4	7.3	7.3	6.7	7.3	7.2	6.9	7.2	7.1	7	7.1	7.1	6.8	6.8	6.9	165
170	5.9	7.3		6.2	7.3	7.3	6.5	7.2	7.2	6.7	7.2	7.1	6.8	7.1	7.1	6.5	6.7	6.8	170
175	5.8	7.3		6.1	7.3	7.3	6.3	7.2	7.2	6.5	7.2	7.1	6.6	7.1	7.1	6.3	6.5	6.7	175
180	5.6	7.3		5.9	7.3		6.2	7.2	7.2	6.4	7.2	7.1	6.5	7.1	7.1	6	6.3	6.5	180
185	5.5			5.8	7.3		6	7.2	7.2	6.3	7.1	7.1	6.3	7.1	7.1	5.7	6	6.3	185
190				5.7	7.3		5.9	7.2		6.1	7.1	7.1	6.1	6.8	7	5.5	5.8	6.1	190
195				5.6	7.3		5.8	7.1		5.9	7	7.1	5.8	6.3	6.7	5.2	5.5	5.8	195
200				5.5			5.7	6.8		5.8	6.6	6.8	5.3	5.9	6.2	4.9	5.3	5.5	200
205							5.6	6.6		5.7	6.2		4.9	5.4	5.7	4.2	5	5.2	205
210							5.5	6.2		5.4	5.7		4.5	5	5.2	3	4.6	4.9	210
215							5.3			5	5.3		4	4.6			3.7	4.3	215
220										4.7	4.9		3.1	4.2			2.4	3.1	220
225										4.4	4.5		2.1	3.2					225
230										3.4				2					230



LIFTING CHARTS - All Terrain Cranes

LIEBHERR MODEL LTM 1160-5.2 - 190 TON CAPACITY

Lifting heights Hauteurs de levage

TNZK

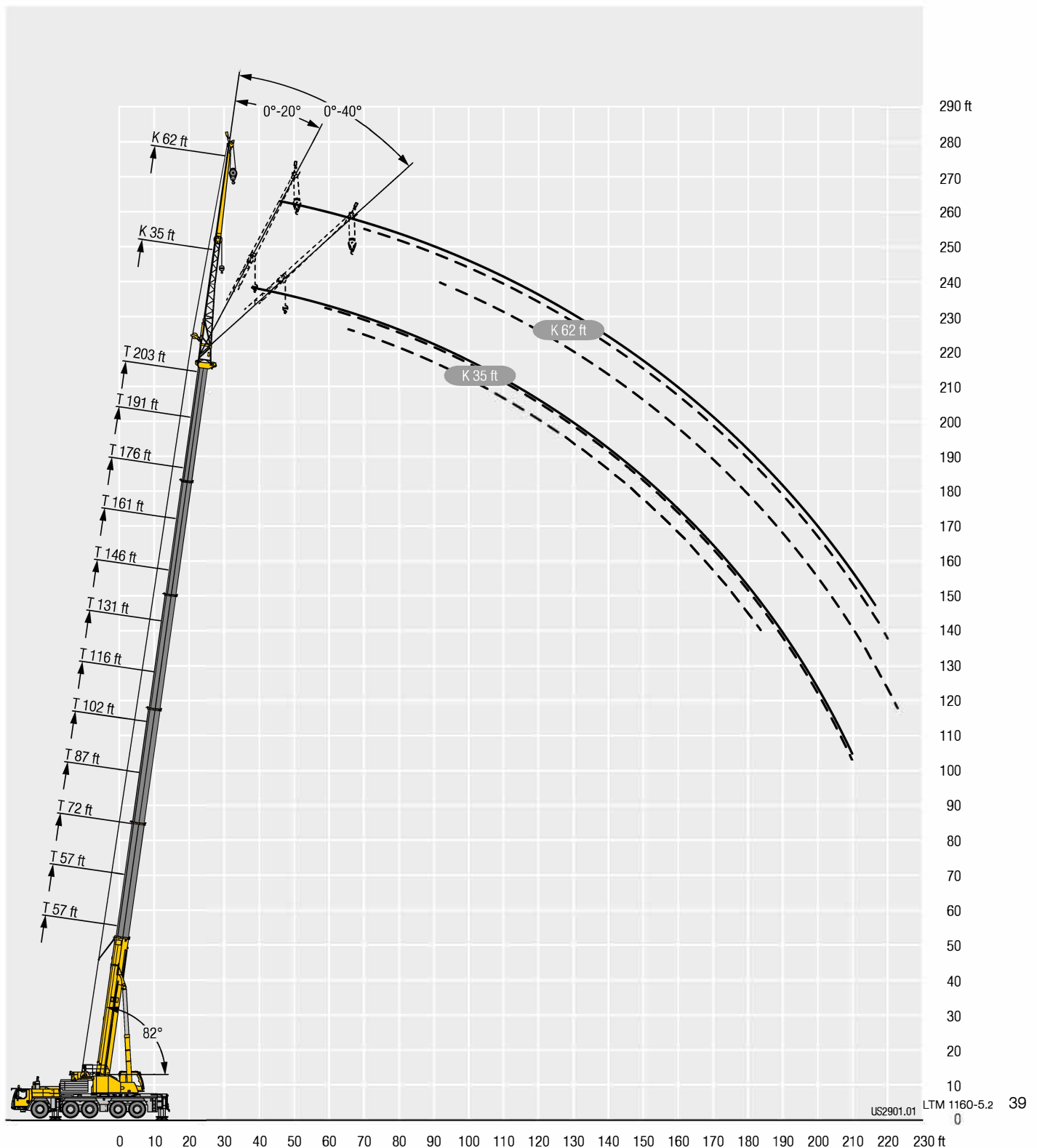

STERLING CRANE



LIFTING CHARTS - All Terrain Cranes

LIEBHERR MODEL LTM 1160-5.2 - 190 TON CAPACITY

Lifting capacities Forces de levage

TVNZK



Lifting hook icon	43 ft + 23 ft			57 ft + 23 ft			72 ft + 23 ft			87 ft + 23 ft			102 ft + 23 ft			116 ft + 23 ft			Lifting hook icon
	35 ft			35 ft			35 ft			35 ft			35 ft			35 ft			
	0°	20°	40°	0°	20°	40°	0°	20°	40°	0°	20°	40°	0°	20°	40°	0°	20°	40°	
17	19.2			19.7			20.2			20.2									17
18	19.3			19.8			20.1			20.2									18
19	19.3			19.7			20			20.2			20.2						19
20	19.2			19.6			20			20.2			20.2						20
22	18.8	17.2		19.4			19.8			20			20.2						22
24	18.3	17.1		19.2	17.2		19.6			19.9			20.1			20.2			24
26	17.7	16.6		18.8	17.2		19.3	17.2		19.7			19.9			20.1			26
28	17.2	16.1		18.3	16.8		19.1	17.2		19.5	17.2		19.8			20			28
30	16.7	15.6	14.8	17.9	16.4		18.8	17		19.3	17.2		19.6			19.9			30
32	16.2	15.1	14.8	17.4	15.9	14.8	18.4	16.6		19.1	17.2		19.4	17.2		19.7			32
34	15.7	14.7	14.4	16.9	15.5	14.8	18	16.2	14.8	18.8	16.8		19.3	17.2		19.6	17.2		34
36	15.2	14.2	14	16.5	15.1	14.6	17.6	15.9	14.8	18.5	16.5		19.1	17		19.4	17.2		36
38	14.7	13.8	13.6	16.1	14.7	14.2	17.1	15.5	14.7	18.1	16.1	14.8	18.8	16.7		19.2	17.1		38
40	14.1	13.4	13.2	15.6	14.4	13.9	16.7	15.1	14.4	17.7	15.8	14.8	18.5	16.3	14.8	19.1	16.8		40
45	12.8	12.6	12.4	14.5	13.5	13.1	15.8	14.3	13.7	16.8	15	14.2	17.6	15.6	14.6	18.4	16.1	14.8	45
50	11.8	11.8	11.7	13.4	12.7	12.4	14.8	13.5	13	15.9	14.2	13.5	16.8	14.9	14	17.6	15.4	14.4	50
55	10.9	11.1	11.1	12.3	12	11.8	13.8	12.8	12.4	15	13.6	12.9	16	14.2	13.4	16.8	14.8	13.8	55
60	10.1	10.4	10.6	11.5	11.5	11.3	12.8	12.2	11.8	14.1	12.9	12.4	15.2	13.6	12.8	16.1	14.2	13.3	60
65	9.4	9.7	10.1	10.7	10.8	10.8	12	11.7	11.4	13.2	12.4	11.9	14.4	13	12.4	15.4	13.6	12.8	65
70	8.8	9	9.4	10	10.2	10.4	11.2	11.2	11	12.4	11.9	11.5	13.6	12.5	11.9	14.6	13.1	12.4	70
75	8.2	8.4	8.7	9.4	9.6	9.9	10.6	10.6	10.6	11.7	11.4	11.1	12.8	12	11.6	13.9	12.6	12	75
80	7.7	7.9	8.1	8.9	9	9.3	10	10	10.3	11	10.9	10.8	12.1	11.6	11.2	13.1	12.1	11.6	80
85	7.3	7.5	7.6	8.4	8.5	8.7	9.5	9.5	9.7	10.5	10.4	10.5	11.5	11.2	10.9	12.4	11.8	11.3	85
90	6.9	7.1	7.5	7.9	8.1	8.2	9	9	9.2	10	9.9	10.1	10.9	10.7	10.6	11.9	11.4	11	90
95				7.5	7.6		8.5	8.6	8.8	9.5	9.5	9.6	10.4	10.3	10.3	11.3	11	10.8	95
100				7.2	7.3		8.1	8.2	8.3	9	9	9.2	9.9	9.8	9.9	10.8	10.6	10.5	100
105				6.9	6.9		7.7	7.8		8.6	8.6	8.8	9.5	9.4	9.5	10.4	10.1	10.2	105
110							7.4	7.5		8.3	8.3	8.4	9.1	9	9.2	9.9	9.8	9.8	110
115							7.1	7.2		7.9	7.9	8	8.7	8.7	8.8	9.5	9.4	9.5	115
120							6.9	6.9		7.6	7.6		8.4	8.3	8.5	9.2	9	9.1	120
125										7.3	7.3		8	8	8.1	8.8	8.7	8.8	125
130										7	7.1		7.7	7.7		8.5	8.4	8.5	130
135										6.8			7.5	7.5		8.2	8.1	8.2	135
140													7.2	7.2		7.9	7.8		140
145													7	7		7.6	7.6		145
150													6.8			7.4	7.4		150
155																7.1	7.1		155
160																6.9	7		160
165																6.8			165



LIFTING CHARTS - All Terrain Cranes

LIEBHERR MODEL LTM 1160-5.2 - 190 TON CAPACITY

Lifting capacities Forces de levage

TVNZK



Lifting hook icon	131 ft + 23 ft			146 ft + 23 ft			161 ft + 23 ft			176 ft + 23 ft			191 ft + 23 ft			203 ft + 23 ft			Lifting hook icon
	35 ft			35 ft			35 ft			35 ft			35 ft			35 ft			
	0°	20°	40°	0°	20°	40°	0°	20°	40°	0°	20°	40°	0°	20°	40°	0°	20°	40°	
26	20.2																		26
28	20.1																		28
30	20.1			20.2															30
32	19.9			20.1			18.4												32
34	19.8			20			18.3												34
36	19.7			19.9			18.3			15.7									36
38	19.5	17.2		19.7			18.2			15.6									38
40	19.4	17.2		19.6			18.1			15.6			13						40
45	18.9	16.6		19.3	17		17.9			15.4			12.9			11.1			45
50	18.3	15.9	14.7	18.8	16.3	14.8	17.7	16.7		15.2	15.2		12.7			11			50
55	17.6	15.3	14.2	18.2	15.7	14.5	17.4	16.1	14.7	15.1	14.8		12.6	12.8		10.9			55
60	16.8	14.7	13.7	17.5	15.2	14	17.1	15.6	14.3	14.9	14.5	13.4	12.5	12.6		10.9	11		60
65	16.2	14.1	13.2	16.8	14.6	13.5	16.8	15.1	13.9	14.7	14.1	13.1	12.4	12.4	11.9	10.8	10.8		65
70	15.5	13.6	12.7	16.2	14.1	13.1	16.4	14.6	13.4	14.5	13.7	12.7	12.3	12.2	11.7	10.7	10.7	10.7	70
75	14.8	13.1	12.3	15.6	13.6	12.7	15.8	14.1	13	14.3	13.2	12.4	12.2	11.9	11.4	10.5	10.5	10.5	75
80	14.1	12.7	12	15	13.2	12.3	15.3	13.7	12.7	14	12.9	12.1	12.1	11.7	11.2	10.3	10.3	10.3	80
85	13.5	12.3	11.7	14.4	12.8	12	14.8	13.2	12.3	13.6	12.5	11.8	11.9	11.4	11	10.1	10	10	85
90	12.8	11.9	11.4	13.7	12.4	11.7	14.3	12.8	12	13.3	12.2	11.5	11.7	11.2	10.8	9.9	9.8	9.8	90
95	12.2	11.6	11.1	13.1	12	11.4	13.9	12.5	11.8	12.9	11.9	11.3	11.5	11	10.6	9.7	9.5	9.5	95
100	11.7	11.2	10.9	12.5	11.7	11.2	13.3	12.1	11.5	12.6	11.6	11.1	11.2	10.8	10.5	9.4	9.3	9.3	100
105	11.1	10.8	10.6	12	11.4	11	12.8	11.8	11.3	12.2	11.3	10.9	10.9	10.6	10.3	9.2	9	9	105
110	10.7	10.4	10.4	11.5	11	10.7	12.2	11.5	11	11.9	11.1	10.7	10.7	10.4	10.1	8.9	8.8	8.8	110
115	10.3	10.1	10.1	11	10.7	10.5	11.8	11.2	10.8	11.6	10.8	10.5	10.4	10.1	10	8.7	8.6	8.5	115
120	9.9	9.7	9.7	10.6	10.3	10.3	11.3	10.9	10.6	11.3	10.6	10.3	10.1	9.9	9.8	8.4	8.3	8.3	120
125	9.5	9.4	9.4	10.3	10	10	10.9	10.5	10.4	11.1	10.4	10.2	9.9	9.7	9.7	8.2	8.1	8.1	125
130	9.2	9	9.1	9.9	9.7	9.7	10.6	10.2	10.2	10.9	10.2	10	9.6	9.5	9.5	8	7.9	7.9	130
135	8.8	8.7	8.8	9.5	9.3	9.4	10.2	9.9	9.9	10.6	10.1	9.9	9.4	9.2	9.3	7.8	7.7	7.7	135
140	8.6	8.4	8.5	9.2	9	9.1	9.9	9.6	9.6	10.4	9.9	9.7	9.1	9	9	7.6	7.5	7.5	140
145	8.3	8.2	8.3	8.9	8.7	8.8	9.6	9.3	9.3	10.2	9.7	9.6	8.9	8.8	8.8	7.4	7.3	7.3	145
150	8	7.9	8	8.6	8.5	8.6	9.3	9	9.1	9.9	9.5	9.5	8.7	8.6	8.6	7.2	7.1	7.1	150
155	7.7	7.7		8.4	8.2	8.3	9	8.8	8.8	9.6	9.3	9.3	8.5	8.4	8.4	7	6.9	7	155
160	7.5	7.5		8.1	8	8.1	8.7	8.5	8.6	9.3	9	9.1	8.3	8.2	8.2	6.7	6.7	6.8	160
165	7.3	7.3		7.9	7.8		8.4	8.3	8.4	9	8.8	8.8	8.1	8	8.1	6.4	6.6	6.6	165
170	7.1	7.1		7.6	7.6		8.2	8.1	8.1	8.5	8.6	8.6	7.9	7.8	7.9	6.2	6.3	6.4	170
175	6.9	6.9		7.4	7.4		8	7.9		7.9	8.3	8.4	7.7	7.7	7.7	5.9	6.1	6.2	175
180	6.8			7.2	7.2		7.7	7.7		7.5	7.7	7.9	7.4	7.5	7.6	5.6	5.8	6	180
185				7	7		7.5	7.5		7.3	7.3	7.4	6.9	7.3	7.3	5.3	5.5	5.7	185
190				6.9	6.9		7.2	7.3		7.1	7.2		6.4	6.8	6.9	5	5.2	5.4	190
195				6.8			6.7	6.9		6.8	6.9		5.9	6.2	6.4	4.5	5	5.1	195
200							6.3	6.5		6.3	6.5		5.5	5.8		3.2	4.4	4.6	200
205							6.1			5.9	6.1		4.2	5.2			3.2	3.7	205
210							5.9			5.5	5.7		3.1	3.9					210
215										5.1	5.3		1.8	2.7					215
220										4.1									220
225										3.2									225

STERLING CRANE



LIFTING CHARTS - All Terrain Cranes

LIEBHERR MODEL LTM 1160-5.2 - 190 TON CAPACITY

Lifting capacities Forces de levage

TVNZK



43-203 ft T	43 ft + 23 ft			57 ft + 23 ft			72 ft + 23 ft			87 ft + 23 ft			102 ft + 23 ft			116 ft + 23 ft			119000 lbs	360°	85%
	35 ft			35 ft			35 ft			35 ft			35 ft			35 ft					
	0°	20°	40°	0°	20°	40°	0°	20°	40°	0°	20°	40°	0°	20°	40°	0°	20°	40°			
17	19.2			19.7			20.2			20.2											
18	19.3			19.8			20.1			20.2											
19	19.3			19.7			20			20.2			20.2								
20	19.2			19.6			20			20.2			20.2								
22	18.8	17.2		19.4			19.8			20			20.2								
24	18.3	17.1		19.2	17.2		19.6			19.9			20.1			20.2					
26	17.7	16.6		18.8	17.2		19.3	17.2		19.7			19.9			20.1					
28	17.2	16.1		18.3	16.8		19.1	17.2		19.5	17.2		19.8			20					
30	16.7	15.6	14.8	17.9	16.4		18.8	17		19.3	17.2		19.6			19.9					
32	16.2	15.1	14.8	17.4	15.9	14.8	18.4	16.6		19.1	17.2		19.4	17.2		19.7					
34	15.7	14.7	14.4	16.9	15.5	14.8	18	16.2	14.8	18.8	16.8		19.3	17.2		19.6	17.2				
36	15.2	14.2	14	16.5	15.1	14.6	17.6	15.9	14.8	18.5	16.5		19.1	17		19.4	17.2				
38	14.7	13.8	13.6	16.1	14.7	14.2	17.1	15.5	14.7	18.1	16.1	14.8	18.8	16.7		19.2	17.1				
40	14.1	13.4	13.2	15.6	14.4	13.9	16.7	15.1	14.4	17.7	15.8	14.8	18.5	16.3	14.8	19.1	16.8				
45	12.8	12.6	12.4	14.5	13.5	13.1	15.8	14.3	13.7	16.8	15	14.2	17.6	15.6	14.6	18.4	16.1	14.8			
50	11.8	11.8	11.7	13.4	12.7	12.4	14.8	13.5	13	15.9	14.2	13.5	16.8	14.9	14	17.6	15.4	14.4			
55	10.9	11.1	11.1	12.3	12	11.8	13.8	12.8	12.4	15	13.6	12.9	16	14.2	13.4	16.8	14.8	13.8			
60	10.1	10.4	10.6	11.5	11.5	11.3	12.8	12.2	11.8	14.1	12.9	12.4	15.2	13.6	12.8	16.1	14.2	13.3			
65	9.4	9.7	10.1	10.7	10.8	10.8	12	11.7	11.4	13.2	12.4	11.9	14.4	13	12.4	15.4	13.6	12.8			
70	8.8	9	9.4	10	10.2	10.4	11.2	11.2	11	12.4	11.9	11.5	13.6	12.5	11.9	14.6	13.1	12.4			
75	8.2	8.4	8.7	9.4	9.6	9.9	10.6	10.6	10.6	11.7	11.4	11.1	12.8	12	11.6	13.9	12.6	12			
80	7.7	7.9	8.1	8.9	9	9.3	10	10	10.3	11	10.9	10.8	12.1	11.6	11.2	13.1	12.1	11.6			
85	7.3	7.5	7.6	8.4	8.5	8.7	9.5	9.5	9.7	10.5	10.4	10.5	11.5	11.2	10.9	12.4	11.8	11.3			
90	6.9	7.1	7.5	7.9	8.1	8.2	9	9	9.2	10	9.9	10.1	10.9	10.7	10.6	11.9	11.4	11			
95				7.5	7.6		8.5	8.6	8.8	9.5	9.5	9.6	10.4	10.3	10.3	11.3	11	10.8			
100				7.2	7.3		8.1	8.2	8.3	9	9	9.2	9.9	9.8	9.9	10.8	10.6	10.5			
105				6.9	6.9		7.7	7.8		8.6	8.6	8.8	9.5	9.4	9.5	10.4	10.1	10.2			
110							7.4	7.5		8.3	8.3	8.4	9.1	9	9.2	9.9	9.8	9.8			
115							7.1	7.2		7.9	7.9	8	8.7	8.7	8.8	9.5	9.4	9.5			
120							6.9	6.9		7.6	7.6		8.4	8.3	8.5	9.2	9	9.1			
125										7.3	7.3		8	8	8.1	8.8	8.7	8.8			
130										7	7.1		7.7	7.7		8.5	8.4	8.5			
135										6.8			7.5	7.5		8.2	8.1	8.2			
140													7.2	7.2		7.9	7.8				
145													7	7		7.6	7.6				
150													6.8			7.4	7.4				
155																7.1	7.1				
160																6.9	7				
165																6.8					

STERLING CRANE



LIFTING CHARTS - All Terrain Cranes

LIEBHERR MODEL LTM 1160-5.2 - 190 TON CAPACITY

Lifting capacities Forces de levage

TVNZK



Lifting hook icon	131 ft + 23 ft			146 ft + 23 ft			161 ft + 23 ft			176 ft + 23 ft			191 ft + 23 ft			203 ft + 23 ft			Lifting hook icon
	35 ft			35 ft			35 ft			35 ft			35 ft			35 ft			
	0°	20°	40°	0°	20°	40°	0°	20°	40°	0°	20°	40°	0°	20°	40°	0°	20°	40°	
26	20.2																		26
28	20.1																		28
30	20.1			20.2															30
32	19.9			20.1			18.4												32
34	19.8			20			18.3												34
36	19.7			19.9			18.3			15.7									36
38	19.5	17.2		19.7			18.2			15.6									38
40	19.4	17.2		19.6			18.1			15.6			13						40
45	18.9	16.6		19.3	17		17.9			15.4			12.9			11.1			45
50	18.3	15.9	14.7	18.8	16.3	14.8	17.7	16.7		15.2	15.2		12.7			11			50
55	17.6	15.3	14.2	18.2	15.7	14.5	17.4	16.1	14.7	15.1	14.8		12.6	12.8		10.9			55
60	16.8	14.7	13.7	17.5	15.2	14	17.1	15.6	14.3	14.9	14.5	13.4	12.5	12.6		10.9	11		60
65	16.2	14.1	13.2	16.8	14.6	13.5	16.8	15.1	13.9	14.7	14.1	13.1	12.4	12.4	11.9	10.8	10.8		65
70	15.5	13.6	12.7	16.2	14.1	13.1	16.4	14.6	13.4	14.5	13.7	12.7	12.3	12.2	11.7	10.7	10.7	10.7	70
75	14.8	13.1	12.3	15.6	13.6	12.7	15.8	14.1	13	14.3	13.2	12.4	12.2	11.9	11.4	10.5	10.5	10.5	75
80	14.1	12.7	12	15	13.2	12.3	15.3	13.7	12.7	14	12.9	12.1	12.1	11.7	11.2	10.3	10.3	10.3	80
85	13.5	12.3	11.7	14.4	12.8	12	14.8	13.2	12.3	13.6	12.5	11.8	11.9	11.4	11	10.1	10	10	85
90	12.8	11.9	11.4	13.7	12.4	11.7	14.3	12.8	12	13.3	12.2	11.5	11.7	11.2	10.8	9.9	9.8	9.8	90
95	12.2	11.6	11.1	13.1	12	11.4	13.9	12.5	11.8	12.9	11.9	11.3	11.5	11	10.6	9.7	9.5	9.5	95
100	11.7	11.2	10.9	12.5	11.7	11.2	13.3	12.1	11.5	12.6	11.6	11.1	11.2	10.8	10.5	9.4	9.3	9.3	100
105	11.1	10.8	10.6	12	11.4	11	12.8	11.8	11.3	12.2	11.3	10.9	10.9	10.6	10.3	9.2	9	9	105
110	10.7	10.4	10.4	11.5	11	10.7	12.2	11.5	11	11.9	11.1	10.7	10.7	10.4	10.1	8.9	8.8	8.8	110
115	10.3	10.1	10.1	11	10.7	10.5	11.8	11.2	10.8	11.6	10.8	10.5	10.4	10.1	10	8.7	8.6	8.5	115
120	9.9	9.7	9.7	10.6	10.3	10.3	11.3	10.9	10.6	11.3	10.6	10.3	10.1	9.9	9.8	8.4	8.3	8.3	120
125	9.5	9.4	9.4	10.3	10	10	10.9	10.5	10.4	11.1	10.4	10.2	9.9	9.7	9.7	8.2	8.1	8.1	125
130	9.2	9	9.1	9.9	9.7	9.7	10.6	10.2	10.2	10.9	10.2	10	9.6	9.5	9.5	8	7.9	7.9	130
135	8.8	8.7	8.8	9.5	9.3	9.4	10.2	9.9	9.9	10.6	10.1	9.9	9.4	9.2	9.3	7.8	7.7	7.7	135
140	8.6	8.4	8.5	9.2	9	9.1	9.9	9.6	9.6	10.4	9.9	9.7	9.1	9	9	7.6	7.5	7.5	140
145	8.3	8.2	8.3	8.9	8.7	8.8	9.6	9.3	9.3	10.2	9.7	9.6	8.9	8.8	8.8	7.4	7.3	7.3	145
150	8	7.9	8	8.6	8.5	8.6	9.3	9	9.1	9.9	9.5	9.5	8.7	8.6	8.6	7.2	7.1	7.1	150
155	7.7	7.7		8.4	8.2	8.3	9	8.8	8.8	9.6	9.3	9.3	8.5	8.4	8.4	7	6.9	7	155
160	7.5	7.5		8.1	8	8.1	8.7	8.5	8.6	9	9	9.1	8.3	8.2	8.2	6.7	6.7	6.8	160
165	7.3	7.3		7.9	7.8		8.4	8.3	8.4	8.3	8.7	8.8	8.1	8	8.1	6.4	6.6	6.6	165
170	7.1	7.1		7.6	7.6		8.2	8.1	8.1	7.9	8.2	8.4	7.7	7.8	7.9	6.2	6.3	6.4	170
175	6.9	6.9		7.4	7.4		8	7.9		7.7	7.7	7.8	7.3	7.6	7.7	5.9	6.1	6.2	175
180	6.8			7.2	7.2		7.5	7.7		7.5	7.5	7.6	6.7	7.1	7.3	5.6	5.8	6	180
185				7	7		7	7.3		7	7.3	7.4	6.2	6.6	6.8	5.3	5.5	5.7	185
190				6.9	6.9		6.8	6.8		6.6	6.8		5.7	6.1	6.2	4.9	5.2	5.4	190
195				6.8			6.5	6.6		6.1	6.4		5.3	5.6	5.7	4	4.9	5.1	195
200							6.3	6.4		5.7	5.9		4.8	5.1		2.7	3.9	4.4	200
205							6			5.3	5.5		3.7	4.7			2.7	3.2	205
210							5.6			4.9	5.1		2.5	3.5					210
215										4.5	4.7			2.1					215
220										3.7									220
225										2.7									225



LIFTING CHARTS - All Terrain Cranes

LIEBHERR MODEL LTM 1160-5.2 - 190 TON CAPACITY

Lifting capacities Forces de levage

TVNZK



Lift Height (ft)	43 ft + 23 ft			57 ft + 23 ft			72 ft + 23 ft			87 ft + 23 ft			102 ft + 23 ft			116 ft + 23 ft			Lift Height (ft)
	62 ft			62 ft			62 ft			62 ft			62 ft			62 ft			
	0°	20°	40°	0°	20°	40°	0°	20°	40°	0°	20°	40°	0°	20°	40°	0°	20°	40°	
17	11			11			11												17
18	11			11			11												18
19	10.9			11			11												19
20	10.9			11			11			11									20
22	10.9			10.9			11			11									22
24	10.8			10.9			11			11			11						24
26	10.7			10.9			10.9			11			11			11			26
28	10.7			10.8			10.9			10.9			11			11			28
30	10.6			10.7			10.8			10.9			11			11			30
32	10.5			10.7			10.8			10.9			10.9			11			32
34	10.3			10.6			10.7			10.8			10.9			10.9			34
36	10.2	10		10.5			10.7			10.8			10.9			10.9			36
38	10.1	10		10.4	10		10.6			10.7			10.8			10.9			38
40	9.9	9.8		10.3	10		10.5	10		10.7			10.8			10.8			40
45	9.5	9.3		10	9.7		10.3	9.9		10.5	10		10.6	10		10.7			45
50	9	8.9		9.5	9.2		10	9.5		10.3	9.8		10.4	9.9		10.6	10		50
55	8.6	8.4	8.4	9.1	8.8	8.4	9.6	9.1		10	9.4		10.2	9.7		10.4	9.9		55
60	8.2	8.1	8	8.7	8.4	8.3	9.2	8.8	8.4	9.6	9.1	8.4	10	9.3		10.2	9.6		60
65	7.8	7.7	7.7	8.3	8.1	7.9	8.8	8.4	8.2	9.3	8.7	8.3	9.7	9	8.4	10	9.3	8.3	65
70	7.4	7.3	7.4	8	7.8	7.6	8.5	8.1	7.9	8.9	8.4	8.1	9.4	8.7	8.2	9.7	9	8.1	70
75	7.1	7	7.1	7.7	7.5	7.4	8.2	7.8	7.6	8.6	8.2	7.8	9	8.4	8	9.4	8.7	8	75
80	6.8	6.7	6.8	7.3	7.2	7.1	7.9	7.5	7.4	8.3	7.9	7.6	8.7	8.2	7.8	9.1	8.4	7.9	80
85	6.5	6.5	6.6	7.1	6.9	6.9	7.6	7.3	7.2	8	7.6	7.4	8.4	7.9	7.6	8.8	8.2	7.8	85
90	6.2	6.2	6.3	6.8	6.6	6.7	7.3	7	6.9	7.8	7.4	7.2	8.2	7.7	7.4	8.6	8	7.6	90
95	6	6	6.1	6.5	6.4	6.4	7	6.8	6.7	7.5	7.1	7	7.9	7.5	7.2	8.3	7.7	7.4	95
100	5.7	5.8	6	6.2	6.2	6.3	6.8	6.6	6.6	7.2	6.9	6.8	7.7	7.2	7	8	7.5	7.2	100
105	5.6	5.6	5.9	6	6	6.1	6.5	6.3	6.4	7	6.7	6.6	7.4	7	6.9	7.8	7.3	7	105
110	5.3	5.5	5.8	5.8	5.8	6	6.3	6.2	6.2	6.8	6.5	6.5	7.2	6.8	6.7	7.6	7.1	6.9	110
115	5.1	5.3	5.5	5.6	5.6	5.9	6.1	6	6.1	6.5	6.3	6.3	7	6.6	6.6	7.4	6.9	6.8	115
120	4.9	5.1		5.5	5.5	5.8	5.9	5.8	6	6.3	6.1	6.2	6.7	6.5	6.4	7.2	6.8	6.6	120
125				5.2	5.4		5.7	5.7	5.9	6.1	6	6.1	6.5	6.3	6.3	7	6.6	6.5	125
130				5	5.2		5.6	5.6	5.8	6	5.8	6	6.4	6.1	6.2	6.7	6.4	6.4	130
135				4.9			5.4	5.5	5.7	5.8	5.7	5.9	6.2	6	6.1	6.5	6.3	6.2	135
140							5.2	5.3		5.6	5.6	5.8	6	5.9	6	6.4	6.1	6.1	140
145							5	5.1		5.5	5.5	5.8	5.8	5.7	5.9	6.2	6	6.1	145
150							4.9			5.3	5.4		5.7	5.6	5.8	6	5.9	6	150
155										5.1	5.3		5.6	5.5	5.8	5.9	5.8	5.9	155
160										5	5.1		5.4	5.5	5.7	5.8	5.7	5.8	160
165										4.9			5.2	5.3		5.6	5.6	5.8	165
170													5.1	5.2		5.5	5.5	5.8	170
175													4.9	5.1		5.3	5.4		175
180													4.9			5.2	5.3		180
185																5.1	5.2		185
190																4.9	5.1		190
195																4.9			195

STERLING CRANE



LIFTING CHARTS - All Terrain Cranes

LIEBHERR MODEL LTM 1160-5.2 - 190 TON CAPACITY

Lifting capacities Forces de levage

TVNZK



Lift Height (ft)	131 ft + 23 ft			146 ft + 23 ft			161 ft + 23 ft			176 ft + 23 ft			191 ft + 23 ft			203 ft + 23 ft			Lift Height (ft)
	0°	20°	40°	0°	20°	40°	0°	20°	40°	0°	20°	40°	0°	20°	40°	0°	20°	40°	
30	11																		30
32	11																		32
34	11			10.7															34
36	10.9			10.8			10.6												36
38	10.9			11			10.7												38
40	10.9			10.9			10.7												40
45	10.8			10.9			10.6			9.7			8.3						45
50	10.7			10.8			10.5			9.6			8.4			7.2			50
55	10.6	10		10.7			10.4			9.5			8.4			7.4			55
60	10.4	9.8		10.5	9.8		10.3			9.4			8.4			7.4			60
65	10.2	9.5		10.4	9.6		10.2	9.3		9.4			8.3			7.4			65
70	10	9.2	8.1	10.2	9.4		10.1	9.1		9.3	8.8		8.2			7.3			70
75	9.7	8.9	8	10	9.1	7.9	10	9		9.2	8.6		8.2	8.1		7.3			75
80	9.5	8.7	7.9	9.8	8.9	7.8	9.8	8.8	7.8	9.1	8.5		8.1	8		7.3	7.4		80
85	9.2	8.4	7.8	9.5	8.7	7.8	9.6	8.7	7.7	9	8.4	7.6	8	7.8		7.2	7.3		85
90	8.9	8.2	7.7	9.2	8.4	7.7	9.4	8.5	7.6	8.8	8.2	7.5	8	7.7	7.2	7.2	7.2		90
95	8.7	8	7.6	9	8.2	7.6	9.2	8.3	7.5	8.7	8	7.4	7.9	7.6	7.1	7.1	7.1	6.8	95
100	8.4	7.8	7.4	8.7	8	7.5	9	8.2	7.5	8.5	7.9	7.3	7.8	7.4	7.1	7.1	6.9	6.7	100
105	8.2	7.6	7.2	8.5	7.8	7.4	8.8	8	7.4	8.4	7.7	7.3	7.7	7.3	6.9	7	6.8	6.6	105
110	7.9	7.4	7.1	8.3	7.6	7.3	8.6	7.8	7.3	8.2	7.5	7.1	7.6	7.1	6.8	6.9	6.7	6.5	110
115	7.7	7.2	6.9	8.1	7.5	7.1	8.4	7.6	7.2	8	7.4	7	7.4	7	6.7	6.8	6.6	6.4	115
120	7.5	7	6.8	7.9	7.3	7	8.1	7.4	7.1	7.8	7.2	6.9	7.3	6.9	6.6	6.6	6.5	6.3	120
125	7.3	6.9	6.7	7.7	7.1	6.9	7.9	7.3	7	7.6	7.1	6.8	7.2	6.7	6.5	6.5	6.4	6.2	125
130	7.1	6.7	6.6	7.5	7	6.7	7.7	7.1	6.8	7.5	7	6.7	7.1	6.6	6.4	6.4	6.3	6.1	130
135	6.9	6.6	6.4	7.3	6.8	6.6	7.5	7	6.7	7.3	6.8	6.6	6.9	6.5	6.3	6.2	6.2	6.1	135
140	6.7	6.4	6.3	7.1	6.7	6.5	7.4	6.8	6.6	7.2	6.7	6.5	6.8	6.4	6.2	6.1	6	6	140
145	6.6	6.2	6.2	6.9	6.5	6.4	7.2	6.7	6.5	7	6.5	6.4	6.7	6.2	6.1	5.9	5.9	5.9	145
150	6.4	6.1	6.1	6.7	6.4	6.3	7	6.5	6.4	6.8	6.4	6.3	6.5	6.1	6	5.8	5.8	5.8	150
155	6.2	6	6	6.6	6.2	6.2	6.8	6.4	6.3	6.7	6.3	6.2	6.4	6	6	5.6	5.6	5.7	155
160	6.1	5.9	6	6.4	6.1	6.1	6.7	6.3	6.2	6.5	6.2	6.1	6.3	5.9	5.9	5.5	5.5	5.6	160
165	6	5.8	5.9	6.3	6	6	6.5	6.2	6.1	6.4	6.1	6	6.1	5.9	5.8	5.4	5.3	5.4	165
170	5.8	5.7	5.9	6.1	5.9	6	6.4	6	6	6.3	5.9	5.9	6	5.8	5.8	5.2	5.2	5.3	170
175	5.7	5.6	5.8	6	5.8	5.9	6.2	5.9	5.9	6.1	5.9	5.9	5.9	5.7	5.7	5.1	5.1	5.2	175
180	5.6	5.5	5.8	5.9	5.7	5.9	6.1	5.8	5.9	6	5.8	5.8	5.8	5.6	5.6	4.9	5	5.1	180
185	5.5	5.5		5.7	5.6	5.8	6	5.7	5.8	5.9	5.7	5.8	5.7	5.5	5.6	4.8	4.8	4.9	185
190	5.3	5.3		5.6	5.5	5.8	5.9	5.7	5.8	5.8	5.6	5.7	5.6	5.4	5.5	4.6	4.7	4.8	190
195	5.2	5.2		5.5	5.5	5.7	5.7	5.6	5.8	5.7	5.5	5.7	5.5	5.4	5.5	4.4	4.6	4.7	195
200	5	5.1		5.4	5.4		5.6	5.5	5.7	5.6	5.4	5.6	5.4	5.3	5.5	3.9	4.5	4.6	200
205	4.9	5.1		5.3	5.3		5.5	5.4	5.7	5.5	5.4	5.6	5.2	5.2	5.4	2.9	4.3	4.5	205
210	4.8			5.1	5.2		5.4	5.4		5.3	5.3	5.6	4	5.2	5.4		3.8	4.3	210
215				5	5.1		5.3	5.3		5.2	5.2	5.5	2.9	4.7	5.4			3.8	215
220				4.9	5.1		5.2	5.3		5	5.1	5.4		3.6	4.4				220
225				2.2			5	5.1		4	4.9			2.4	3.1				225
230							4.7	4.8		3	4.1								230
235							4.6			2	2.9								235
240											1.9								240

STERLING CRANE



LIFTING CHARTS - All Terrain Cranes

LIEBHERR MODEL LTM 1160-5.2 - 190 TON CAPACITY

Lifting capacities Forces de levage

TVNZK

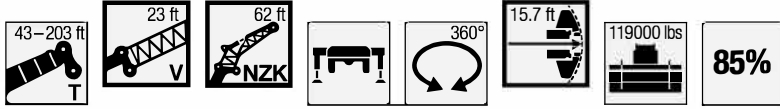

Lift Height (ft)	43 ft + 23 ft			57 ft + 23 ft			72 ft + 23 ft			87 ft + 23 ft			102 ft + 23 ft			116 ft + 23 ft			Lift Height (ft)
	62 ft			62 ft			62 ft			62 ft			62 ft			62 ft			
	0°	20°	40°	0°	20°	40°	0°	20°	40°	0°	20°	40°	0°	20°	40°	0°	20°	40°	
17	11			11			11												17
18	11			11			11												18
19	10.9			11			11												19
20	10.9			11			11			11									20
22	10.9			10.9			11			11									22
24	10.8			10.9			11			11			11						24
26	10.7			10.9			10.9			11			11			11			26
28	10.7			10.8			10.9			10.9			11			11			28
30	10.6			10.7			10.8			10.9			11			11			30
32	10.5			10.7			10.8			10.9			10.9			11			32
34	10.3			10.6			10.7			10.8			10.9			10.9			34
36	10.2	10		10.5			10.7			10.8			10.9			10.9			36
38	10.1	10		10.4	10		10.6			10.7			10.8			10.9			38
40	9.9	9.8		10.3	10		10.5	10		10.7			10.8			10.8			40
45	9.5	9.3		10	9.7		10.3	9.9		10.5	10		10.6	10		10.7			45
50	9	8.9		9.5	9.2		10	9.5		10.3	9.8		10.4	9.9		10.6	10		50
55	8.6	8.4	8.4	9.1	8.8	8.4	9.6	9.1		10	9.4		10.2	9.7		10.4	9.9		55
60	8.2	8.1	8	8.7	8.4	8.3	9.2	8.8	8.4	9.6	9.1	8.4	10	9.3		10.2	9.6		60
65	7.8	7.7	7.7	8.3	8.1	7.9	8.8	8.4	8.2	9.3	8.7	8.3	9.7	9	8.4	10	9.3	8.3	65
70	7.4	7.3	7.4	8	7.8	7.6	8.5	8.1	7.9	8.9	8.4	8.1	9.4	8.7	8.2	9.7	9	8.1	70
75	7.1	7	7.1	7.7	7.5	7.4	8.2	7.8	7.6	8.6	8.2	7.8	9	8.4	8	9.4	8.7	8	75
80	6.8	6.7	6.8	7.3	7.2	7.1	7.9	7.5	7.4	8.3	7.9	7.6	8.7	8.2	7.8	9.1	8.4	7.9	80
85	6.5	6.5	6.6	7.1	6.9	6.9	7.6	7.3	7.2	8	7.6	7.4	8.4	7.9	7.6	8.8	8.2	7.8	85
90	6.2	6.2	6.3	6.8	6.6	6.7	7.3	7	6.9	7.8	7.4	7.2	8.2	7.7	7.4	8.6	8	7.6	90
95	6	6	6.1	6.5	6.4	6.4	7	6.8	6.7	7.5	7.1	7	7.9	7.5	7.2	8.3	7.7	7.4	95
100	5.7	5.8	6	6.2	6.2	6.3	6.8	6.6	6.6	7.2	6.9	6.8	7.7	7.2	7	8	7.5	7.2	100
105	5.6	5.6	5.9	6	6	6.1	6.5	6.3	6.4	7	6.7	6.6	7.4	7	6.9	7.8	7.3	7	105
110	5.3	5.5	5.8	5.8	5.8	6	6.3	6.2	6.2	6.8	6.5	6.5	7.2	6.8	6.7	7.6	7.1	6.9	110
115	5.1	5.3	5.5	5.6	5.6	5.9	6.1	6	6.1	6.5	6.3	6.3	7	6.6	6.6	7.4	6.9	6.8	115
120	4.9	5.1		5.5	5.5	5.8	5.9	5.8	6	6.3	6.1	6.2	6.7	6.5	6.4	7.2	6.8	6.6	120
125				5.2	5.4		5.7	5.7	5.9	6.1	6	6.1	6.5	6.3	6.3	7	6.6	6.5	125
130				5	5.2		5.6	5.6	5.8	6	5.8	6	6.4	6.1	6.2	6.7	6.4	6.4	130
135				4.9			5.4	5.5	5.7	5.8	5.7	5.9	6.2	6	6.1	6.5	6.3	6.2	135
140							5.2	5.3		5.6	5.6	5.8	6	5.9	6	6.4	6.1	6.1	140
145							5	5.1		5.5	5.5	5.8	5.8	5.7	5.9	6.2	6	6.1	145
150							4.9			5.3	5.4		5.7	5.6	5.8	6	5.9	6	150
155										5.1	5.3		5.6	5.5	5.8	5.9	5.8	5.9	155
160										5	5.1		5.4	5.5	5.7	5.8	5.7	5.8	160
165										4.9			5.2	5.3		5.6	5.6	5.8	165
170													5.1	5.2		5.5	5.5	5.8	170
175													4.9	5.1		5.3	5.4		175
180													4.9			5.2	5.3		180
185																5.1	5.2		185
190																4.9	5.1		190
195																4.9			195

STERLING CRANE



LIFTING CHARTS - All Terrain Cranes

LIEBHERR MODEL LTM 1160-5.2 - 190 TON CAPACITY

Lifting capacities Forces de levage

TVNZK



Lift Height (ft)	131 ft + 23 ft			146 ft + 23 ft			161 ft + 23 ft			176 ft + 23 ft			191 ft + 23 ft			203 ft + 23 ft			Lift Height (ft)
	0°	20°	40°	0°	20°	40°	0°	20°	40°	0°	20°	40°	0°	20°	40°	0°	20°	40°	
30	11																		30
32	11																		32
34	11			10.7															34
36	10.9			10.8			10.6												36
38	10.9			11			10.7												38
40	10.9			10.9			10.7												40
45	10.8			10.9			10.6			9.7			8.3						45
50	10.7			10.8			10.5			9.6			8.4			7.2			50
55	10.6	10		10.7			10.4			9.5			8.4			7.4			55
60	10.4	9.8		10.5	9.8		10.3			9.4			8.4			7.4			60
65	10.2	9.5		10.4	9.6		10.2	9.3		9.4			8.3			7.4			65
70	10	9.2	8.1	10.2	9.4		10.1	9.1		9.3	8.8		8.2			7.3			70
75	9.7	8.9	8	10	9.1	7.9	10	9		9.2	8.6		8.2	8.1		7.3			75
80	9.5	8.7	7.9	9.8	8.9	7.8	9.8	8.8	7.8	9.1	8.5		8.1	8		7.3	7.4		80
85	9.2	8.4	7.8	9.5	8.7	7.8	9.6	8.7	7.7	9	8.4	7.6	8	7.8		7.2	7.3		85
90	8.9	8.2	7.7	9.2	8.4	7.7	9.4	8.5	7.6	8.8	8.2	7.5	8	7.7	7.2	7.2	7.2		90
95	8.7	8	7.6	9	8.2	7.6	9.2	8.3	7.5	8.7	8	7.4	7.9	7.6	7.1	7.1	7.1	6.8	95
100	8.4	7.8	7.4	8.7	8	7.5	9	8.2	7.5	8.5	7.9	7.3	7.8	7.4	7.1	7.1	6.9	6.7	100
105	8.2	7.6	7.2	8.5	7.8	7.4	8.8	8	7.4	8.4	7.7	7.3	7.7	7.3	6.9	7	6.8	6.6	105
110	7.9	7.4	7.1	8.3	7.6	7.3	8.6	7.8	7.3	8.2	7.5	7.1	7.6	7.1	6.8	6.9	6.7	6.5	110
115	7.7	7.2	6.9	8.1	7.5	7.1	8.4	7.6	7.2	8	7.4	7	7.4	7	6.7	6.8	6.6	6.4	115
120	7.5	7	6.8	7.9	7.3	7	8.1	7.4	7.1	7.8	7.2	6.9	7.3	6.9	6.6	6.6	6.5	6.3	120
125	7.3	6.9	6.7	7.7	7.1	6.9	7.9	7.3	7	7.6	7.1	6.8	7.2	6.7	6.5	6.5	6.4	6.2	125
130	7.1	6.7	6.6	7.5	7	6.7	7.7	7.1	6.8	7.5	7	6.7	7.1	6.6	6.4	6.4	6.3	6.1	130
135	6.9	6.6	6.4	7.3	6.8	6.6	7.5	7	6.7	7.3	6.8	6.6	6.9	6.5	6.3	6.2	6.2	6.1	135
140	6.7	6.4	6.3	7.1	6.7	6.5	7.4	6.8	6.6	7.2	6.7	6.5	6.8	6.4	6.2	6.1	6	6	140
145	6.6	6.2	6.2	6.9	6.5	6.4	7.2	6.7	6.5	7	6.5	6.4	6.7	6.2	6.1	5.9	5.9	5.9	145
150	6.4	6.1	6.1	6.7	6.4	6.3	7	6.5	6.4	6.8	6.4	6.3	6.5	6.1	6	5.8	5.8	5.8	150
155	6.2	6	6	6.6	6.2	6.2	6.8	6.4	6.3	6.7	6.3	6.2	6.4	6	6	5.6	5.6	5.7	155
160	6.1	5.9	6	6.4	6.1	6.1	6.7	6.3	6.2	6.5	6.2	6.1	6.3	5.9	5.9	5.5	5.5	5.6	160
165	6	5.8	5.9	6.3	6	6	6.5	6.2	6.1	6.4	6.1	6	6.1	5.9	5.8	5.4	5.3	5.4	165
170	5.8	5.7	5.9	6.1	5.9	6	6.4	6	6	6.3	5.9	5.9	6	5.8	5.8	5.2	5.2	5.3	170
175	5.7	5.6	5.8	6	5.8	5.9	6.2	5.9	5.9	6.1	5.9	5.9	5.9	5.7	5.7	5.1	5.1	5.2	175
180	5.6	5.5	5.8	5.9	5.7	5.9	6.1	5.8	5.9	6	5.8	5.8	5.8	5.6	5.6	4.9	5	5.1	180
185	5.5	5.5		5.7	5.6	5.8	6	5.7	5.8	5.9	5.7	5.8	5.7	5.5	5.6	4.8	4.8	4.9	185
190	5.3	5.3		5.6	5.5	5.8	5.9	5.7	5.8	5.8	5.6	5.7	5.6	5.4	5.5	4.6	4.7	4.8	190
195	5.2	5.2		5.5	5.5	5.7	5.7	5.6	5.8	5.7	5.5	5.7	5.5	5.4	5.5	4.4	4.6	4.7	195
200	5	5.1		5.4	5.4		5.6	5.5	5.7	5.5	5.4	5.6	5.3	5.3	5.5	3.5	4.5	4.6	200
205	4.9	5.1		5.3	5.3		5.5	5.4	5.7	5.4	5.3	5.5	4.7	5.2	5.4		4.3	4.5	205
210	4.8			5.1	5.2		5.4	5.3		5.3	5.2	5.5	3.5	5.1	5.4		3.6	4.3	210
215				5	5.1		5.1	5.3		5	5.2	5.5	2.4	4.3	5			3.6	215
220				4.9	5.1		5	5.1		4.5	5	5.2		3.1	4				220
225				2.2			4.9	5		3.5	4.5			1.8	2.6				225
230							4.7	4.8		2.5	3.6								230
235							4.4					2.5							235



LIFTING CHARTS - All Terrain Cranes

LIEBHERR MODEL LTM 1160-5.2 - 190 TON CAPACITY

Lifting heights Hauteurs de levage

TVNZK

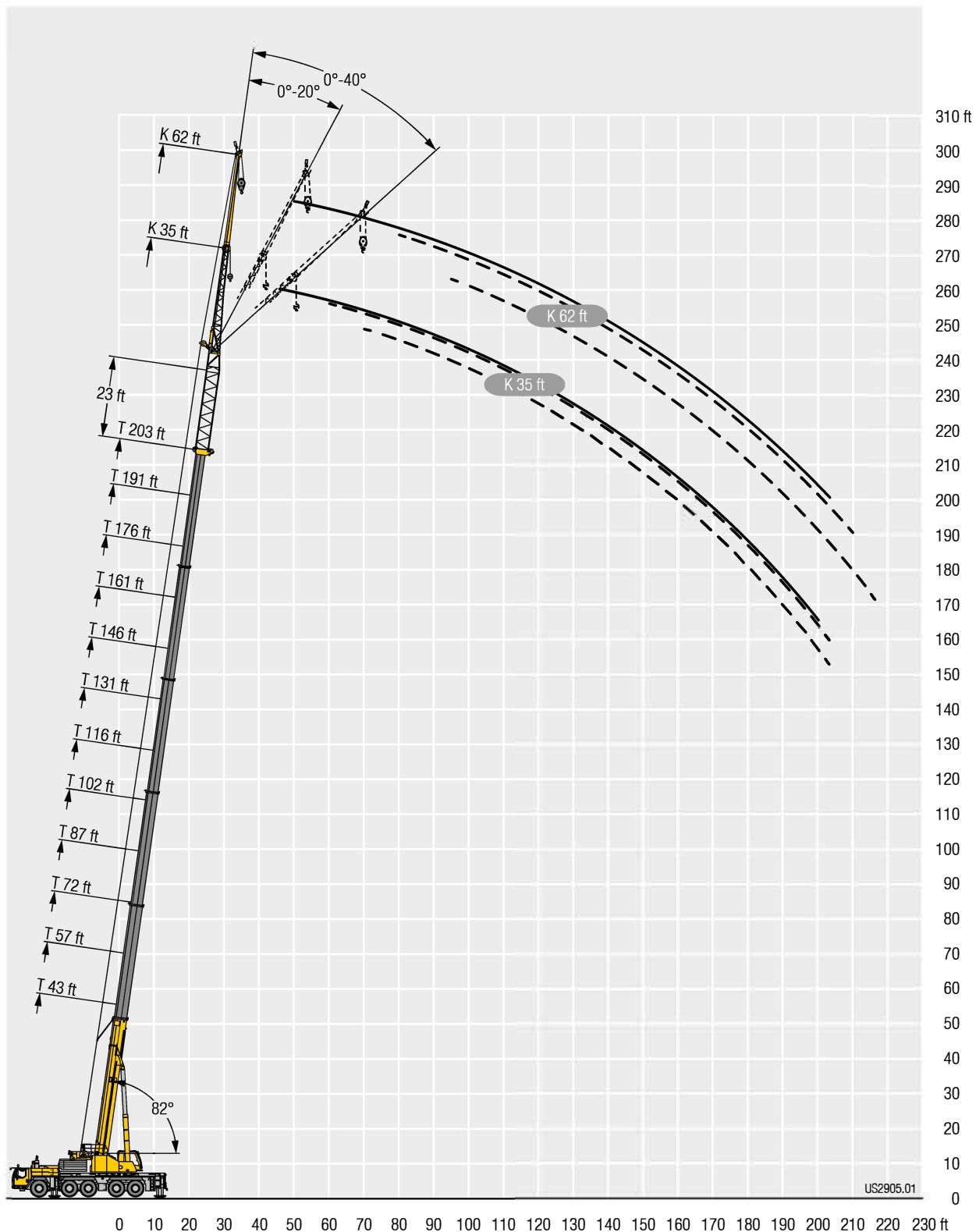



LIFTING CHARTS - All Terrain Cranes

LIEBHERR MODEL LTM 1160-5.2 - 190 TON CAPACITY

Lifting capacities Forces de levage

TVNZK

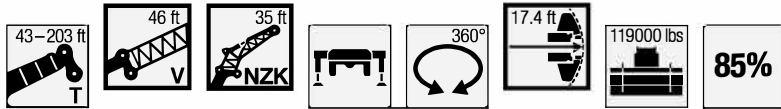

Lift Height (ft)	43 ft + 46 ft			57 ft + 46 ft			72 ft + 46 ft			87 ft + 46 ft			102 ft + 46 ft			116 ft + 46 ft			Lift Height (ft)
	35 ft			35 ft			35 ft			35 ft			35 ft			35 ft			
	0°	20°	40°	0°	20°	40°	0°	20°	40°	0°	20°	40°	0°	20°	40°	0°	20°	40°	
17	12.4			12.5															17
18	12.4			12.5			12.5												18
19	12.3			12.5			12.5												19
20	12.2			12.4			12.5			12.5									20
22	12.1			12.3			12.4			12.5									22
24	11.9			12.2			12.3			12.5			12.5						24
26	11.8	11.8		12			12.2			12.4			12.5			12.5			26
28	11.6	11.8		11.9	11.8		12.1			12.3			12.4			12.5			28
30	11.3	11.5		11.8	11.8		12	11.8		12.2			12.3			12.4			30
32	11.1	11.2		11.6	11.6		11.9	11.8		12.1	11.8		12.2			12.4			32
34	10.8	10.8	10.5	11.4	11.3		11.8	11.7		12	11.8		12.1			12.3			34
36	10.6	10.6	10.5	11.1	11.1	10.5	11.6	11.5		11.9	11.8		12	11.8		12.2			36
38	10.3	10.3	10.3	10.9	10.8	10.5	11.4	11.2	10.5	11.8	11.6		11.9	11.8		12.1	11.8		38
40	10.1	10	10.1	10.7	10.5	10.4	11.2	11	10.5	11.6	11.4		11.8	11.7		12	11.8		40
45	9.5	9.4	9.5	10.1	9.9	9.9	10.7	10.4	10.2	11.1	10.8	10.5	11.5	11.2	10.5	11.8	11.5		45
50	8.9	8.8	8.9	9.6	9.4	9.3	10.2	9.9	9.7	10.7	10.3	10	11.1	10.7	10.3	11.4	11	10.5	50
55	8.4	8.3	8.4	9	8.9	8.9	9.7	9.4	9.3	10.2	9.8	9.6	10.7	10.2	9.9	11	10.6	10.2	55
60	7.9	7.9	7.9	8.6	8.4	8.4	9.2	8.9	8.8	9.7	9.4	9.2	10.2	9.8	9.5	10.6	10.1	9.8	60
65	7.5	7.5	7.5	8.1	8	8	8.7	8.5	8.4	9.3	9	8.8	9.8	9.4	9.1	10.2	9.7	9.4	65
70	7.1	7.1	7.2	7.7	7.6	7.7	8.3	8.1	8.1	8.9	8.6	8.5	9.4	9	8.8	9.9	9.4	9.1	70
75	6.7	6.7	6.8	7.4	7.3	7.3	8	7.8	7.7	8.5	8.2	8.1	9	8.6	8.5	9.5	9	8.8	75
80	6.4	6.4	6.5	7	6.9	7	7.6	7.4	7.4	8.2	7.9	7.8	8.6	8.3	8.2	9.1	8.7	8.5	80
85	6	6.1	6.1	6.7	6.6	6.7	7.3	7.1	7.1	7.8	7.6	7.5	8.3	8	7.9	8.8	8.4	8.2	85
90	5.7	5.7	5.9	6.4	6.3	6.4	7	6.8	6.9	7.5	7.3	7.2	8	7.7	7.6	8.5	8.1	7.9	90
95	5.5	5.5	5.6	6.1	6.1	6.1	6.7	6.6	6.6	7.2	7	7	7.7	7.4	7.3	8.2	7.8	7.7	95
100	5.2	5.3	5.4	5.8	5.8	5.9	6.4	6.3	6.3	6.9	6.8	6.7	7.4	7.2	7.1	7.9	7.6	7.4	100
105	5	5.1	5.2	5.6	5.5	5.6	6.1	6.1	6.1	6.6	6.5	6.5	7.1	6.9	6.9	7.6	7.3	7.2	105
110	4.8	4.9	5.2	5.3	5.3	5.5	5.9	5.8	5.9	6.4	6.3	6.3	6.9	6.7	6.7	7.3	7.1	7	110
115	4.6	4.6		5.1	5.2		5.6	5.6	5.7	6.1	6.1	6.1	6.6	6.5	6.4	7.1	6.8	6.8	115
120				4.9	5		5.4	5.4	5.5	5.9	5.8	5.9	6.4	6.2	6.2	6.8	6.6	6.6	120
125				4.7	4.8		5.2	5.2		5.7	5.6	5.7	6.2	6.1	6.1	6.6	6.4	6.4	125
130				4.5			5.1	5.1		5.5	5.5	5.5	5.9	5.8	5.9	6.4	6.2	6.2	130
135							4.9	4.9		5.3	5.3		5.8	5.6	5.7	6.2	6.1	6	135
140							4.7	4.8		5.2	5.1		5.6	5.5	5.6	6	5.9	5.9	140
145							4.5			5	5		5.4	5.4	5.4	5.8	5.7	5.7	145
150										4.8	4.9		5.2	5.2		5.6	5.5	5.6	150
155										4.7	4.7		5.1	5.1		5.5	5.4	5.5	155
160										4.5			4.9	5		5.3	5.3		160
165													4.8	4.8		5.2	5.1		165
170													4.6	4.7		5	5		170
175													4.5			4.9	4.9		175
180																4.7	4.8		180
185																4.6			185
190																4.5			190

STERLING CRANE



LIFTING CHARTS - All Terrain Cranes

LIEBHERR MODEL LTM 1160-5.2 - 190 TON CAPACITY

Lifting capacities Forces de levage

TVNZK



Lifting hook icon	131 ft + 46 ft			146 ft + 46 ft			161 ft + 46 ft			176 ft + 46 ft			191 ft + 46 ft			203 ft + 46 ft			Lifting hook icon
	35 ft			35 ft			35 ft			35 ft			35 ft			35 ft			
	0°	20°	40°	0°	20°	40°	0°	20°	40°	0°	20°	40°	0°	20°	40°	0°	20°	40°	
30	12.5																		30
32	12.5																		32
34	12.4			12.5															34
36	12.3			12.4			12.4												36
38	12.2			12.4			12.3												38
40	12.1			12.3			12.3			10.7									40
45	11.9	11.7		12.1			12.1			10.6			8.9						45
50	11.7	11.3		11.9	11.6		11.9	11.8		10.5			9			7.4			50
55	11.4	10.9	10.4	11.6	11.2	10.5	11.8	11.4		10.4	10.4		8.9			7.6			55
60	11	10.5	10	11.3	10.8	10.3	11.5	11	10.4	10.3	10.1		8.8	8.9		7.6			60
65	10.6	10.1	9.7	11	10.4	9.9	11.3	10.7	10.1	10.1	9.9	9.5	8.7	8.8		7.6	7.7		65
70	10.3	9.7	9.4	10.6	10	9.6	10.9	10.3	9.8	9.9	9.6	9.3	8.6	8.6	8.5	7.5	7.6		70
75	9.9	9.4	9.1	10.3	9.7	9.3	10.6	10	9.5	9.7	9.4	9	8.5	8.5	8.3	7.5	7.5	7.5	75
80	9.5	9	8.8	9.9	9.4	9	10.3	9.6	9.3	9.6	9.1	8.8	8.4	8.3	8.1	7.4	7.5	7.4	80
85	9.2	8.7	8.5	9.6	9	8.7	10	9.3	9	9.3	8.9	8.5	8.3	8.1	7.9	7.3	7.4	7.3	85
90	8.9	8.4	8.2	9.3	8.7	8.5	9.7	9.1	8.7	9.1	8.6	8.3	8.2	7.9	7.7	7.3	7.2	7.1	90
95	8.6	8.2	8	9	8.5	8.2	9.3	8.8	8.5	8.8	8.4	8.1	8	7.7	7.5	7.2	7.1	7	95
100	8.3	7.9	7.7	8.7	8.2	8	9	8.5	8.2	8.6	8.1	7.9	7.9	7.5	7.3	7.1	6.9	6.8	100
105	8	7.7	7.5	8.4	8	7.8	8.8	8.3	8	8.3	7.9	7.7	7.7	7.3	7.2	7	6.8	6.7	105
110	7.8	7.4	7.3	8.2	7.8	7.6	8.5	8	7.8	8.1	7.7	7.5	7.5	7.2	7	6.8	6.7	6.6	110
115	7.5	7.2	7.1	7.9	7.5	7.4	8.2	7.8	7.6	7.9	7.5	7.3	7.3	7	6.9	6.6	6.5	6.5	115
120	7.3	7	6.9	7.7	7.3	7.2	8	7.6	7.4	7.7	7.3	7.2	7.1	6.9	6.7	6.4	6.4	6.3	120
125	7	6.8	6.7	7.4	7.1	7	7.8	7.4	7.2	7.5	7.1	7	7	6.7	6.6	6.3	6.2	6.2	125
130	6.8	6.6	6.5	7.2	6.9	6.8	7.6	7.2	7	7.3	7	6.8	6.8	6.5	6.4	6.1	6.1	6.1	130
135	6.6	6.4	6.4	7	6.7	6.6	7.3	7	6.9	7.1	6.8	6.7	6.6	6.4	6.3	6	5.9	5.9	135
140	6.4	6.2	6.2	6.8	6.5	6.5	7.1	6.8	6.7	6.9	6.6	6.5	6.5	6.3	6.2	5.8	5.7	5.8	140
145	6.2	6.1	6	6.6	6.4	6.3	6.9	6.6	6.5	6.7	6.5	6.4	6.3	6.1	6	5.6	5.6	5.6	145
150	6	5.9	5.9	6.4	6.2	6.2	6.7	6.5	6.4	6.5	6.3	6.2	6.2	6	5.9	5.5	5.4	5.5	150
155	5.8	5.7	5.7	6.2	6.1	6	6.5	6.3	6.2	6.4	6.2	6.1	6	5.9	5.8	5.3	5.3	5.3	155
160	5.7	5.6	5.6	6	5.9	5.9	6.3	6.1	6.1	6.2	6	6	5.9	5.7	5.7	5.1	5.1	5.2	160
165	5.5	5.4	5.5	5.9	5.7	5.8	6.2	6	5.9	6.1	5.9	5.8	5.8	5.6	5.6	5	5	5	165
170	5.4	5.3		5.7	5.6	5.6	6	5.8	5.8	5.9	5.7	5.7	5.7	5.5	5.5	4.8	4.8	4.9	170
175	5.3	5.2		5.6	5.5	5.5	5.9	5.7	5.7	5.8	5.6	5.6	5.5	5.4	5.4	4.7	4.7	4.8	175
180	5.1	5.1		5.4	5.4	5.4	5.7	5.6	5.6	5.6	5.5	5.5	5.4	5.3	5.3	4.5	4.6	4.6	180
185	5	5		5.3	5.2		5.6	5.4	5.5	5.5	5.4	5.4	5.3	5.2	5.2	4.3	4.4	4.5	185
190	4.8	4.9		5.2	5.1		5.4	5.3	5.4	5.4	5.3	5.3	5.2	5.1	5.1	3.8	4.3	4.4	190
195	4.7	4.8		5.1	5.1		5.3	5.2		5.3	5.2	5.2	4.9	5	5.1		3.8	4.2	195
200	4.6			4.9	5		5.2	5.1		5.2	5.1	5.2	3.7	4.7	4.9			3.5	200
205	4.5			4.8	4.8		5	5		5	5		2.3	3.7	4.4				205
210				4.7	4.7		5	4.9		4.3	4.8				3				210
215				4.6			4.9	4.9		3.3	4.1								215
220				4.1			4.5	4.8		2.2	3								220
225							4.2	4.4			1.8								225
230							3.3												230
235							1.9												235



LIFTING CHARTS - All Terrain Cranes

LIEBHERR MODEL LTM 1160-5.2 - 190 TON CAPACITY

Lifting capacities Forces de levage

TVNZK



Lift Height (ft)	43 ft + 46 ft			57 ft + 46 ft			72 ft + 46 ft			87 ft + 46 ft			102 ft + 46 ft			116 ft + 46 ft			Lift Height (ft)
	0°	20°	40°	0°	20°	40°	0°	20°	40°	0°	20°	40°	0°	20°	40°	0°	20°	40°	
17	12.4			12.5															17
18	12.4			12.5			12.5												18
19	12.3			12.5			12.5												19
20	12.2			12.4			12.5			12.5									20
22	12.1			12.3			12.4			12.5									22
24	11.9			12.2			12.3			12.5			12.5						24
26	11.8	11.8		12			12.2			12.4			12.5			12.5			26
28	11.6	11.8		11.9	11.8		12.1			12.3			12.4			12.5			28
30	11.3	11.5		11.8	11.8		12	11.8		12.2			12.3			12.4			30
32	11.1	11.2		11.6	11.6		11.9	11.8		12.1	11.8		12.2			12.4			32
34	10.8	10.8	10.5	11.4	11.3		11.8	11.7		12	11.8		12.1			12.3			34
36	10.6	10.6	10.5	11.1	11.1	10.5	11.6	11.5		11.9	11.8		12	11.8		12.2			36
38	10.3	10.3	10.3	10.9	10.8	10.5	11.4	11.2	10.5	11.8	11.6		11.9	11.8		12.1	11.8		38
40	10.1	10	10.1	10.7	10.5	10.4	11.2	11	10.5	11.6	11.4		11.8	11.7		12	11.8		40
45	9.5	9.4	9.5	10.1	9.9	9.9	10.7	10.4	10.2	11.1	10.8	10.5	11.5	11.2	10.5	11.8	11.5		45
50	8.9	8.8	8.9	9.6	9.4	9.3	10.2	9.9	9.7	10.7	10.3	10	11.1	10.7	10.3	11.4	11	10.5	50
55	8.4	8.3	8.4	9	8.9	8.9	9.7	9.4	9.3	10.2	9.8	9.6	10.7	10.2	9.9	11	10.6	10.2	55
60	7.9	7.9	7.9	8.6	8.4	8.4	9.2	8.9	8.8	9.7	9.4	9.2	10.2	9.8	9.5	10.6	10.1	9.8	60
65	7.5	7.5	7.5	8.1	8	8	8.7	8.5	8.4	9.3	9	8.8	9.8	9.4	9.1	10.2	9.7	9.4	65
70	7.1	7.1	7.2	7.7	7.6	7.7	8.3	8.1	8.1	8.9	8.6	8.5	9.4	9	8.8	9.9	9.4	9.1	70
75	6.7	6.7	6.8	7.4	7.3	7.3	8	7.8	7.7	8.5	8.2	8.1	9	8.6	8.5	9.5	9	8.8	75
80	6.4	6.4	6.5	7	6.9	7	7.6	7.4	7.4	8.2	7.9	7.8	8.6	8.3	8.2	9.1	8.7	8.5	80
85	6	6.1	6.1	6.7	6.6	6.7	7.3	7.1	7.1	7.8	7.6	7.5	8.3	8	7.9	8.8	8.4	8.2	85
90	5.7	5.7	5.9	6.4	6.3	6.4	7	6.8	6.9	7.5	7.3	7.2	8	7.7	7.6	8.5	8.1	7.9	90
95	5.5	5.5	5.6	6.1	6.1	6.1	6.7	6.6	6.6	7.2	7	7	7.7	7.4	7.3	8.2	7.8	7.7	95
100	5.2	5.3	5.4	5.8	5.8	5.9	6.4	6.3	6.3	6.9	6.8	6.7	7.4	7.2	7.1	7.9	7.6	7.4	100
105	5	5.1	5.2	5.6	5.5	5.6	6.1	6.1	6.1	6.6	6.5	6.5	7.1	6.9	6.9	7.6	7.3	7.2	105
110	4.8	4.9	5.2	5.3	5.3	5.5	5.9	5.8	5.9	6.4	6.3	6.3	6.9	6.7	6.7	7.3	7.1	7	110
115	4.6	4.6		5.1	5.2		5.6	5.6	5.7	6.1	6.1	6.1	6.6	6.5	6.4	7.1	6.8	6.8	115
120				4.9	5		5.4	5.4	5.5	5.9	5.8	5.9	6.4	6.2	6.2	6.8	6.6	6.6	120
125				4.7	4.8		5.2	5.2		5.7	5.6	5.7	6.2	6.1	6.1	6.6	6.4	6.4	125
130				4.5			5.1	5.1		5.5	5.5	5.5	5.9	5.8	5.9	6.4	6.2	6.2	130
135							4.9	4.9		5.3	5.3		5.8	5.6	5.7	6.2	6.1	6	135
140							4.7	4.8		5.2	5.1		5.6	5.5	5.6	6	5.9	5.9	140
145							4.5			5	5		5.4	5.4	5.4	5.8	5.7	5.7	145
150										4.8	4.9		5.2	5.2		5.6	5.5	5.6	150
155										4.7	4.7		5.1	5.1		5.5	5.4	5.5	155
160										4.5			4.9	5		5.3	5.3		160
165													4.8	4.8		5.2	5.1		165
170													4.6	4.7		5	5		170
175													4.5			4.9	4.9		175
180																4.7	4.8		180
185																4.6			185
190																4.5			190

STERLING CRANE



LIFTING CHARTS - All Terrain Cranes

LIEBHERR MODEL LTM 1160-5.2 - 190 TON CAPACITY

Lifting capacities Forces de levage

TVNZK



Jib ↙ ↘	131 ft + 46 ft			146 ft + 46 ft			161 ft + 46 ft			176 ft + 46 ft			191 ft + 46 ft			203 ft + 46 ft			Jib ↙ ↘
	35 ft			35 ft			35 ft			35 ft			35 ft			35 ft			
	0°	20°	40°	0°	20°	40°	0°	20°	40°	0°	20°	40°	0°	20°	40°	0°	20°	40°	
30	12.5																		30
32	12.5																		32
34	12.4			12.5															34
36	12.3			12.4			12.4												36
38	12.2			12.4			12.3												38
40	12.1			12.3			12.3			10.7									40
45	11.9	11.7		12.1			12.1			10.6			8.9						45
50	11.7	11.3		11.9	11.6		11.9	11.8		10.5			9			7.4			50
55	11.4	10.9	10.4	11.6	11.2	10.5	11.8	11.4		10.4	10.4		8.9			7.6			55
60	11	10.5	10	11.3	10.8	10.3	11.5	11	10.4	10.3	10.1		8.8	8.9		7.6			60
65	10.6	10.1	9.7	11	10.4	9.9	11.3	10.7	10.1	10.1	9.9	9.5	8.7	8.8		7.6	7.7		65
70	10.3	9.7	9.4	10.6	10	9.6	10.9	10.3	9.8	9.9	9.6	9.3	8.6	8.6	8.5	7.5	7.6		70
75	9.9	9.4	9.1	10.3	9.7	9.3	10.6	10	9.5	9.7	9.4	9	8.5	8.5	8.3	7.5	7.5	7.5	75
80	9.5	9	8.8	9.9	9.4	9	10.3	9.6	9.3	9.6	9.1	8.8	8.4	8.3	8.1	7.4	7.5	7.4	80
85	9.2	8.7	8.5	9.6	9	8.7	10	9.3	9	9.3	8.9	8.5	8.3	8.1	7.9	7.3	7.4	7.3	85
90	8.9	8.4	8.2	9.3	8.7	8.5	9.7	9.1	8.7	9.1	8.6	8.3	8.2	7.9	7.7	7.3	7.2	7.1	90
95	8.6	8.2	8	9	8.5	8.2	9.3	8.8	8.5	8.8	8.4	8.1	8	7.7	7.5	7.2	7.1	7	95
100	8.3	7.9	7.7	8.7	8.2	8	9	8.5	8.2	8.6	8.1	7.9	7.9	7.5	7.3	7.1	6.9	6.8	100
105	8	7.7	7.5	8.4	8	7.8	8.8	8.3	8	8.3	7.9	7.7	7.7	7.3	7.2	7	6.8	6.7	105
110	7.8	7.4	7.3	8.2	7.8	7.6	8.5	8	7.8	8.1	7.7	7.5	7.5	7.2	7	6.8	6.7	6.6	110
115	7.5	7.2	7.1	7.9	7.5	7.4	8.2	7.8	7.6	7.9	7.5	7.3	7.3	7	6.9	6.6	6.5	6.5	115
120	7.3	7	6.9	7.7	7.3	7.2	8	7.6	7.4	7.7	7.3	7.2	7.1	6.9	6.7	6.4	6.4	6.3	120
125	7	6.8	6.7	7.4	7.1	7	7.8	7.4	7.2	7.5	7.1	7	7	6.7	6.6	6.3	6.2	6.2	125
130	6.8	6.6	6.5	7.2	6.9	6.8	7.6	7.2	7	7.3	7	6.8	6.8	6.5	6.4	6.1	6.1	6.1	130
135	6.6	6.4	6.4	7	6.7	6.6	7.3	7	6.9	7.1	6.8	6.7	6.6	6.4	6.3	6	5.9	5.9	135
140	6.4	6.2	6.2	6.8	6.5	6.5	7.1	6.8	6.7	6.9	6.6	6.5	6.5	6.3	6.2	5.8	5.7	5.8	140
145	6.2	6.1	6	6.6	6.4	6.3	6.9	6.6	6.5	6.7	6.5	6.4	6.3	6.1	6	5.6	5.6	5.6	145
150	6	5.9	5.9	6.4	6.2	6.2	6.7	6.5	6.4	6.5	6.3	6.2	6.2	6	5.9	5.5	5.4	5.5	150
155	5.8	5.7	5.7	6.2	6.1	6	6.5	6.3	6.2	6.4	6.2	6.1	6	5.9	5.8	5.3	5.3	5.3	155
160	5.7	5.6	5.6	6	5.9	5.9	6.3	6.1	6.1	6.2	6	6	5.9	5.7	5.7	5.1	5.1	5.2	160
165	5.5	5.4	5.5	5.9	5.7	5.8	6.2	6	5.9	6.1	5.9	5.8	5.8	5.6	5.6	5	5	5	165
170	5.4	5.3		5.7	5.6	5.6	6	5.8	5.8	5.9	5.7	5.7	5.7	5.5	5.5	4.8	4.8	4.9	170
175	5.3	5.2		5.6	5.5	5.5	5.9	5.7	5.7	5.8	5.6	5.6	5.5	5.4	5.4	4.7	4.7	4.8	175
180	5.1	5.1		5.4	5.4	5.4	5.7	5.6	5.6	5.6	5.5	5.5	5.4	5.3	5.3	4.5	4.6	4.6	180
185	5	5		5.3	5.2		5.6	5.4	5.5	5.5	5.4	5.4	5.3	5.2	5.2	4.3	4.4	4.5	185
190	4.8	4.9		5.2	5.1		5.4	5.3	5.4	5.4	5.3	5.3	5.1	5.1	5.1	3.4	4.3	4.4	190
195	4.7	4.8		5.1	5.1		5.3	5.2		5.2	5.2	5.2	4.4	5	5.1		3.6	4.2	195
200	4.6			4.9	5		5.1	5.1		5.1	5	5.1	3.2	4.3	4.8			3.2	200
205	4.5			4.8	4.8		5	5		4.8	4.9			3.2	3.8				205
210				4.7	4.7		4.8	4.9		4	4.6				2.5				210
215				4.6			4.7	4.7		2.8	3.7								215
220				4.1			4.5	4.6			2.5								220
225							3.8	4.2											225
230							2.8												230
235							1.8												235



LIFTING CHARTS - All Terrain Cranes

LIEBHERR MODEL LTM 1160-5.2 - 190 TON CAPACITY

Lifting capacities Forces de levage

TVNZK



Lift Height (ft)	43 ft + 46 ft			57 ft + 46 ft			72 ft + 46 ft			87 ft + 46 ft			102 ft + 46 ft			116 ft + 46 ft			Lift Height (ft)
	0°	20°	40°	0°	20°	40°	0°	20°	40°	0°	20°	40°	0°	20°	40°	0°	20°	40°	
17	8.4																		17
18	8.4																		18
19	8.4			8.4															19
20	8.4			8.4															20
22	8.4			8.4			8.4												22
24	8.3			8.4			8.4			8.4									24
26	8.3			8.3			8.4			8.4									26
28	8.2			8.3			8.4			8.4			8.4						28
30	8.1			8.2			8.3			8.4			8.4			8.4			30
32	8.1			8.2			8.3			8.3			8.4			8.4			32
34	8			8.1			8.2			8.3			8.4			8.4			34
36	7.9			8.1			8.2			8.3			8.3			8.4			36
38	7.8			8			8.1			8.2			8.3			8.3			38
40	7.7	7.7		7.9			8.1			8.2			8.2			8.3			40
45	7.4	7.5		7.6	7.6		7.9	7.7		8			8.1			8.2			45
50	7	7.1		7.4	7.4		7.6	7.6		7.8	7.7		8	7.7		8.1			50
55	6.6	6.7	6.5	7	7		7.4	7.3		7.6	7.5		7.8	7.6		8	7.7		55
60	6.3	6.4	6.5	6.7	6.7	6.5	7.1	6.9	6.5	7.4	7.2		7.6	7.4		7.8	7.6		60
65	5.9	6	6.2	6.4	6.4	6.4	6.8	6.6	6.5	7.1	6.9	6.5	7.4	7.1		7.6	7.3		65
70	5.6	5.7	5.9	6.1	6.1	6.1	6.5	6.3	6.3	6.8	6.6	6.4	7.1	6.8	6.5	7.4	7	6.5	70
75	5.3	5.4	5.5	5.8	5.8	5.8	6.2	6.1	6	6.5	6.3	6.2	6.8	6.6	6.4	7.1	6.8	6.5	75
80	5	5.1	5.3	5.5	5.5	5.5	5.9	5.8	5.8	6.2	6.1	6	6.6	6.3	6.1	6.9	6.5	6.3	80
85	4.8	4.8	5	5.2	5.2	5.3	5.6	5.5	5.5	6	5.8	5.7	6.3	6.1	5.9	6.6	6.3	6.1	85
90	4.5	4.6	4.7	4.9	5	5	5.4	5.3	5.3	5.7	5.6	5.5	6.1	5.8	5.7	6.4	6.1	5.9	90
95	4.3	4.4	4.5	4.7	4.7	4.8	5.1	5	5.1	5.5	5.3	5.3	5.8	5.6	5.5	6.1	5.9	5.7	95
100	4.1	4.2	4.3	4.5	4.5	4.6	4.9	4.8	4.9	5.3	5.1	5.1	5.6	5.4	5.3	5.9	5.7	5.5	100
105	3.9	4	4.1	4.3	4.3	4.4	4.7	4.6	4.7	5	4.9	4.9	5.4	5.2	5.1	5.7	5.5	5.3	105
110	3.7	3.8	3.9	4.1	4.1	4.2	4.5	4.4	4.5	4.8	4.7	4.7	5.2	5	5	5.5	5.3	5.2	110
115	3.6	3.6	3.8	3.9	4	4.1	4.3	4.3	4.3	4.6	4.6	4.6	5	4.8	4.8	5.3	5.1	5	115
120	3.4	3.5	3.6	3.8	3.8	3.9	4.1	4.1	4.2	4.5	4.4	4.4	4.8	4.7	4.6	5.1	4.9	4.8	120
125	3.3	3.3	3.5	3.6	3.6	3.8	4	3.9	4	4.3	4.2	4.3	4.6	4.5	4.5	4.9	4.7	4.7	125
130	3.1	3.2	3.4	3.5	3.5	3.6	3.8	3.8	3.9	4.1	4.1	4.1	4.4	4.3	4.3	4.7	4.6	4.6	130
135	3.1	3.1	3.4	3.3	3.4	3.5	3.7	3.7	3.8	4	3.9	4	4.3	4.2	4.2	4.6	4.4	4.4	135
140	3	3.1		3.2	3.3	3.4	3.5	3.5	3.6	3.8	3.8	3.9	4.1	4.1	4.1	4.4	4.3	4.3	140
145				3.1	3.2		3.4	3.4	3.6	3.7	3.7	3.8	4	3.9	4	4.3	4.2	4.2	145
150				3	3.1		3.3	3.3	3.5	3.6	3.6	3.7	3.9	3.8	3.9	4.1	4	4.1	150
155				3	3.1		3.2	3.2		3.5	3.4	3.6	3.7	3.7	3.8	4	3.9	4	155
160							3.1	3.1		3.3	3.3	3.5	3.6	3.6	3.7	3.9	3.8	3.9	160
165							3	3.1		3.2	3.3	3.4	3.5	3.5	3.6	3.8	3.7	3.8	165
170							3	3.1		3.1	3.2		3.4	3.4	3.5	3.7	3.6	3.7	170
175										3.1	3.1		3.3	3.3	3.4	3.5	3.5	3.6	175
180										3	3.1		3.2	3.2		3.4	3.4	3.5	180
185										3	3.1		3.1	3.1		3.3	3.3	3.5	185
190													3.1	3.1		3.2	3.2	3.4	190
195													3	3.1		3.2	3.2		195
200													3			3.1	3.1		200
205																3	3.1		205
210																3	3.1		210
215																3			215



LIFTING CHARTS - All Terrain Cranes

LIEBHERR MODEL LTM 1160-5.2 - 190 TON CAPACITY

Lifting capacities Forces de levage

TVNZK



Lift Height (ft)	131 ft + 46 ft			146 ft + 46 ft			161 ft + 46 ft			176 ft + 46 ft			191 ft + 46 ft			203 ft + 46 ft			Lift Height (ft)
	0°	20°	40°	0°	20°	40°	0°	20°	40°	0°	20°	40°	0°	20°	40°	0°	20°	40°	
34	8.4																		34
36	8.4																		36
38	8.4			7.4															38
40	8.4			7.6															40
45	8.3			7.9			7.7												45
50	8.2			8.2			8			6.7									50
55	8.1			8.1			8			6.9			5.4						55
60	7.9	7.6		8.1			7.9			7			5.6			4.4			60
65	7.7	7.5		7.9	7.6		7.8			7			5.8			4.6			65
70	7.5	7.2		7.7	7.4		7.7	7.5		6.9			5.9			4.7			70
75	7.4	7	6.5	7.5	7.1		7.6	7.3		6.8	6.8		5.9			4.8			75
80	7.1	6.7	6.4	7.4	6.9	6.5	7.5	7.1		6.8	6.7		5.9	6		4.9			80
85	6.9	6.5	6.2	7.1	6.7	6.4	7.3	6.8	6.5	6.7	6.5		5.8	5.9		5	5.2		85
90	6.7	6.3	6	6.9	6.5	6.2	7.1	6.6	6.3	6.6	6.3	6	5.8	5.7		5	5.1		90
95	6.4	6.1	5.9	6.7	6.3	6	6.9	6.4	6.1	6.5	6.1	5.9	5.7	5.6	5.4	5	5.1		95
100	6.2	5.9	5.7	6.5	6.1	5.8	6.7	6.3	6	6.3	5.9	5.7	5.7	5.5	5.3	4.9	5	4.9	100
105	6	5.7	5.5	6.3	5.9	5.7	6.5	6.1	5.8	6.2	5.8	5.6	5.6	5.4	5.2	4.9	4.9	4.8	105
110	5.8	5.5	5.4	6.1	5.7	5.5	6.3	5.9	5.6	6	5.6	5.4	5.5	5.2	5.1	4.9	4.8	4.7	110
115	5.6	5.3	5.2	5.9	5.5	5.4	6.1	5.7	5.5	5.8	5.5	5.3	5.4	5.1	4.9	4.8	4.7	4.6	115
120	5.4	5.1	5	5.7	5.4	5.2	5.9	5.5	5.3	5.6	5.3	5.1	5.2	4.9	4.8	4.7	4.6	4.5	120
125	5.2	5	4.9	5.5	5.2	5.1	5.7	5.4	5.2	5.5	5.2	5	5.1	4.8	4.7	4.6	4.5	4.4	125
130	5	4.8	4.7	5.3	5	4.9	5.5	5.2	5.1	5.3	5	4.9	5	4.7	4.6	4.5	4.4	4.3	130
135	4.9	4.7	4.6	5.1	4.9	4.8	5.4	5.1	4.9	5.2	4.9	4.8	4.8	4.6	4.5	4.5	4.3	4.2	135
140	4.7	4.5	4.5	5	4.7	4.7	5.2	4.9	4.8	5	4.8	4.6	4.7	4.5	4.4	4.4	4.2	4.1	140
145	4.6	4.4	4.4	4.8	4.6	4.5	5	4.8	4.7	4.9	4.6	4.5	4.6	4.4	4.3	4.3	4.1	4.1	145
150	4.4	4.3	4.2	4.7	4.5	4.4	4.9	4.6	4.5	4.7	4.5	4.4	4.5	4.3	4.2	4.2	4	4	150
155	4.3	4.1	4.1	4.5	4.4	4.3	4.7	4.5	4.4	4.6	4.4	4.3	4.4	4.2	4.1	4.1	3.9	3.9	155
160	4.1	4	4	4.4	4.2	4.2	4.6	4.4	4.3	4.5	4.3	4.2	4.2	4.1	4	4	3.9	3.8	160
165	4	3.9	3.9	4.3	4.1	4.1	4.5	4.3	4.2	4.3	4.2	4.1	4.1	4	3.9	3.9	3.8	3.8	165
170	3.9	3.8	3.8	4.1	4	4	4.3	4.2	4.1	4.2	4.1	4	4	3.9	3.9	3.8	3.7	3.7	170
175	3.8	3.7	3.8	4	3.9	3.9	4.2	4	4	4.1	4	3.9	3.9	3.8	3.8	3.7	3.6	3.6	175
180	3.7	3.6	3.7	3.9	3.8	3.8	4.1	3.9	4	4	3.9	3.9	3.8	3.7	3.7	3.6	3.5	3.6	180
185	3.6	3.5	3.6	3.8	3.7	3.8	4	3.8	3.9	3.9	3.8	3.8	3.7	3.6	3.6	3.5	3.5	3.5	185
190	3.5	3.4	3.5	3.7	3.6	3.7	3.9	3.7	3.8	3.8	3.7	3.7	3.7	3.6	3.6	3.5	3.4	3.4	190
195	3.4	3.4	3.5	3.6	3.5	3.6	3.8	3.7	3.7	3.7	3.6	3.6	3.6	3.5	3.5		3.3	3.4	195
200	3.3	3.3	3.4	3.5	3.5	3.6	3.7	3.6	3.6	3.6	3.5	3.6	3.5	3.4	3.5		3.2	3.3	200
205	3.2	3.2		3.4	3.4	3.5	3.6	3.5	3.6	3.5	3.4	3.5	2.9	3.3	3.4		3.1	3.3	205
210	3.1	3.2		3.3	3.3	3.4	3.5	3.4	3.5	3.5	3.4	3.5		3.3	3.3			3.1	210
215	3.1	3.1		3.3	3.2	3.4	3.4	3.3	3.4	3.3	3.3	3.4			3.3			2.8	215
220	3	3.1		3.2	3.2		3.3	3.3	3.4	2.8	3.3	3.3							220
225	3	3.1		3.1	3.1		3.2	3.2	3.4		3.1	3.3							225
230	3			3.1	3.1		3.1	3.2			2.4	2.9							230
235				3	3.1		2.8	3				1.8							235
240				3	3.1		2	2.8											240
245				3				1.9											245



LIFTING CHARTS - All Terrain Cranes

LIEBHERR MODEL LTM 1160-5.2 - 190 TON CAPACITY

Lifting capacities Forces de levage

TVNZK



Jib	43 ft + 46 ft			57 ft + 46 ft			72 ft + 46 ft			87 ft + 46 ft			102 ft + 46 ft			116 ft + 46 ft			Jib
	62 ft			62 ft			62 ft			62 ft			62 ft			62 ft			
	0°	20°	40°	0°	20°	40°	0°	20°	40°	0°	20°	40°	0°	20°	40°	0°	20°	40°	
17	8.4																		17
18	8.4																		18
19	8.4			8.4															19
20	8.4			8.4															20
22	8.4			8.4			8.4												22
24	8.3			8.4			8.4			8.4									24
26	8.3			8.3			8.4			8.4									26
28	8.2			8.3			8.4			8.4			8.4						28
30	8.1			8.2			8.3			8.4			8.4			8.4			30
32	8.1			8.2			8.3			8.3			8.4			8.4			32
34	8			8.1			8.2			8.3			8.4			8.4			34
36	7.9			8.1			8.2			8.3			8.3			8.4			36
38	7.8			8			8.1			8.2			8.3			8.3			38
40	7.7	7.7		7.9			8.1			8.2			8.2			8.3			40
45	7.4	7.5		7.6	7.6		7.9	7.7		8			8.1			8.2			45
50	7	7.1		7.4	7.4		7.6	7.6		7.8	7.7		8	7.7		8.1			50
55	6.6	6.7	6.5	7	7		7.4	7.3		7.6	7.5		7.8	7.6		8	7.7		55
60	6.3	6.4	6.5	6.7	6.7	6.5	7.1	6.9	6.5	7.4	7.2		7.6	7.4		7.8	7.6		60
65	5.9	6	6.2	6.4	6.4	6.4	6.8	6.6	6.5	7.1	6.9	6.5	7.4	7.1		7.6	7.3		65
70	5.6	5.7	5.9	6.1	6.1	6.1	6.5	6.3	6.3	6.8	6.6	6.4	7.1	6.8	6.5	7.4	7	6.5	70
75	5.3	5.4	5.5	5.8	5.8	5.8	6.2	6.1	6	6.5	6.3	6.2	6.8	6.6	6.4	7.1	6.8	6.5	75
80	5	5.1	5.3	5.5	5.5	5.5	5.9	5.8	5.8	6.2	6.1	6	6.6	6.3	6.1	6.9	6.5	6.3	80
85	4.8	4.8	5	5.2	5.2	5.3	5.6	5.5	5.5	6	5.8	5.7	6.3	6.1	5.9	6.6	6.3	6.1	85
90	4.5	4.6	4.7	4.9	5	5	5.4	5.3	5.3	5.7	5.6	5.5	6.1	5.8	5.7	6.4	6.1	5.9	90
95	4.3	4.4	4.5	4.7	4.7	4.8	5.1	5	5.1	5.5	5.3	5.3	5.8	5.6	5.5	6.1	5.9	5.7	95
100	4.1	4.2	4.3	4.5	4.5	4.6	4.9	4.8	4.9	5.3	5.1	5.1	5.6	5.4	5.3	5.9	5.7	5.5	100
105	3.9	4	4.1	4.3	4.3	4.4	4.7	4.6	4.7	5	4.9	4.9	5.4	5.2	5.1	5.7	5.5	5.3	105
110	3.7	3.8	3.9	4.1	4.1	4.2	4.5	4.4	4.5	4.8	4.7	4.7	5.2	5	5	5.5	5.3	5.2	110
115	3.6	3.6	3.8	3.9	4	4.1	4.3	4.3	4.3	4.6	4.6	4.6	5	4.8	4.8	5.3	5.1	5	115
120	3.4	3.5	3.6	3.8	3.8	3.9	4.1	4.1	4.2	4.5	4.4	4.4	4.8	4.7	4.6	5.1	4.9	4.8	120
125	3.3	3.3	3.5	3.6	3.6	3.8	4	3.9	4	4.3	4.2	4.3	4.6	4.5	4.5	4.9	4.7	4.7	125
130	3.1	3.2	3.4	3.5	3.5	3.6	3.8	3.8	3.9	4.1	4.1	4.1	4.4	4.3	4.3	4.7	4.6	4.6	130
135	3.1	3.1	3.4	3.3	3.4	3.5	3.7	3.7	3.8	4	3.9	4	4.3	4.2	4.2	4.6	4.4	4.4	135
140	3	3.1		3.2	3.3	3.4	3.5	3.5	3.6	3.8	3.8	3.9	4.1	4.1	4.1	4.4	4.3	4.3	140
145				3.1	3.2		3.4	3.4	3.6	3.7	3.7	3.8	4	3.9	4	4.3	4.2	4.2	145
150				3	3.1		3.3	3.3	3.5	3.6	3.6	3.7	3.9	3.8	3.9	4.1	4	4.1	150
155				3	3.1		3.2	3.2		3.5	3.4	3.6	3.7	3.7	3.8	4	3.9	4	155
160							3.1	3.1		3.3	3.3	3.5	3.6	3.6	3.7	3.9	3.8	3.9	160
165							3	3.1		3.2	3.3	3.4	3.5	3.5	3.6	3.8	3.7	3.8	165
170							3	3.1		3.1	3.2		3.4	3.4	3.5	3.7	3.6	3.7	170
175										3.1	3.1		3.3	3.3	3.4	3.5	3.5	3.6	175
180										3	3.1		3.2	3.2		3.4	3.4	3.5	180
185										3	3.1		3.1	3.1		3.3	3.3	3.5	185
190													3.1	3.1		3.2	3.2	3.4	190
195													3	3.1		3.2	3.2		195
200													3			3.1	3.1		200
205																3	3.1		205
210																3	3.1		210
215																3			215

STERLING CRANE



LIFTING CHARTS - All Terrain Cranes

LIEBHERR MODEL LTM 1160-5.2 - 190 TON CAPACITY

Lifting capacities Forces de levage

TVNZK

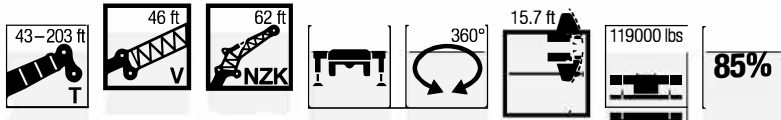

Jib ↙ ↘	131 ft + 46 ft			146 ft + 46 ft			161 ft + 46 ft			176 ft + 46 ft			191 ft + 46 ft			203 ft + 46 ft			Jib ↙ ↘
	62 ft			62 ft			62 ft			62 ft			62 ft			62 ft			
	0°	20°	40°	0°	20°	40°	0°	20°	40°	0°	20°	40°	0°	20°	40°	0°	20°	40°	
34	8.4																		34
36	8.4																		36
38	8.4			7.4															38
40	8.4			7.6															40
45	8.3			7.9			7.7												45
50	8.2			8.2			8			6.7									50
55	8.1			8.1			8			6.9			5.4						55
60	7.9	7.6		8.1			7.9			7			5.6			4.4			60
65	7.7	7.5		7.9	7.6		7.8			7			5.8			4.6			65
70	7.5	7.2		7.7	7.4		7.7	7.5		6.9			5.9			4.7			70
75	7.4	7	6.5	7.5	7.1		7.6	7.3		6.8	6.8		5.9			4.8			75
80	7.1	6.7	6.4	7.4	6.9	6.5	7.5	7.1		6.8	6.7		5.9	6		4.9			80
85	6.9	6.5	6.2	7.1	6.7	6.4	7.3	6.8	6.5	6.7	6.5		5.8	5.9		5	5.2		85
90	6.7	6.3	6	6.9	6.5	6.2	7.1	6.6	6.3	6.6	6.3	6	5.8	5.7		5	5.1		90
95	6.4	6.1	5.9	6.7	6.3	6	6.9	6.4	6.1	6.5	6.1	5.9	5.7	5.6	5.4	5	5.1		95
100	6.2	5.9	5.7	6.5	6.1	5.8	6.7	6.3	6	6.3	5.9	5.7	5.7	5.5	5.3	4.9	5	4.9	100
105	6	5.7	5.5	6.3	5.9	5.7	6.5	6.1	5.8	6.2	5.8	5.6	5.6	5.4	5.2	4.9	4.9	4.8	105
110	5.8	5.5	5.4	6.1	5.7	5.5	6.3	5.9	5.6	6	5.6	5.4	5.5	5.2	5.1	4.9	4.8	4.7	110
115	5.6	5.3	5.2	5.9	5.5	5.4	6.1	5.7	5.5	5.8	5.5	5.3	5.4	5.1	4.9	4.8	4.7	4.6	115
120	5.4	5.1	5	5.7	5.4	5.2	5.9	5.5	5.3	5.6	5.3	5.1	5.2	4.9	4.8	4.7	4.6	4.5	120
125	5.2	5	4.9	5.5	5.2	5.1	5.7	5.4	5.2	5.5	5.2	5	5.1	4.8	4.7	4.6	4.5	4.4	125
130	5	4.8	4.7	5.3	5	4.9	5.5	5.2	5.1	5.3	5	4.9	5	4.7	4.6	4.5	4.4	4.3	130
135	4.9	4.7	4.6	5.1	4.9	4.8	5.4	5.1	4.9	5.2	4.9	4.8	4.8	4.6	4.5	4.5	4.3	4.2	135
140	4.7	4.5	4.5	5	4.7	4.7	5.2	4.9	4.8	5	4.8	4.6	4.7	4.5	4.4	4.4	4.2	4.1	140
145	4.6	4.4	4.4	4.8	4.6	4.5	5	4.8	4.7	4.9	4.6	4.5	4.6	4.4	4.3	4.3	4.1	4.1	145
150	4.4	4.3	4.2	4.7	4.5	4.4	4.9	4.6	4.5	4.7	4.5	4.4	4.5	4.3	4.2	4.2	4	4	150
155	4.3	4.1	4.1	4.5	4.4	4.3	4.7	4.5	4.4	4.6	4.4	4.3	4.4	4.2	4.1	4.1	3.9	3.9	155
160	4.1	4	4	4.4	4.2	4.2	4.6	4.4	4.3	4.5	4.3	4.2	4.2	4.1	4	4	3.9	3.8	160
165	4	3.9	3.9	4.3	4.1	4.1	4.5	4.3	4.2	4.3	4.2	4.1	4.1	4	3.9	3.9	3.8	3.8	165
170	3.9	3.8	3.8	4.1	4	4	4.3	4.2	4.1	4.2	4.1	4	4	3.9	3.9	3.8	3.7	3.7	170
175	3.8	3.7	3.8	4	3.9	3.9	4.2	4	4	4.1	4	3.9	3.9	3.8	3.8	3.7	3.6	3.6	175
180	3.7	3.6	3.7	3.9	3.8	3.8	4.1	3.9	4	4	3.9	3.9	3.8	3.7	3.7	3.6	3.5	3.6	180
185	3.6	3.5	3.6	3.8	3.7	3.8	4	3.8	3.9	3.9	3.8	3.8	3.7	3.6	3.6	3.5	3.5	3.5	185
190	3.5	3.4	3.5	3.7	3.6	3.7	3.9	3.7	3.8	3.8	3.7	3.7	3.7	3.6	3.6	3.4	3.4	3.4	190
195	3.4	3.4	3.5	3.6	3.5	3.6	3.8	3.7	3.7	3.7	3.6	3.6	3.6	3.5	3.5		3.3	3.4	195
200	3.3	3.3	3.4	3.5	3.5	3.6	3.7	3.6	3.6	3.6	3.5	3.6	3.5	3.4	3.5		3.2	3.3	200
205	3.2	3.2		3.4	3.4	3.5	3.6	3.5	3.6	3.5	3.4	3.5		3.3	3.4		2.8	3.3	205
210	3.1	3.2		3.3	3.3	3.4	3.5	3.4	3.5	3.5	3.4	3.5		3.2	3.3			3	210
215	3.1	3.1		3.3	3.2	3.4	3.4	3.3	3.4	3.1	3.3	3.4		3.2				2.3	215
220	3	3.1		3.2	3.2		3.3	3.3	3.4	2.4	3.2	3.3							220
225	3	3.1		3.1	3.1		3.2	3.2	3.4		2.8	3.2							225
230	3			3.1	3.1		3.1	3.2			1.9	2.6							230
235				3	3.1		2.4	3											235
240				3	3.1			2.5											240
245				3															245



LIFTING CHARTS - All Terrain Cranes

LIEBHERR MODEL LTM 1160-5.2 - 190 TON CAPACITY

Lifting heights Hauteurs de levage

TVNZK

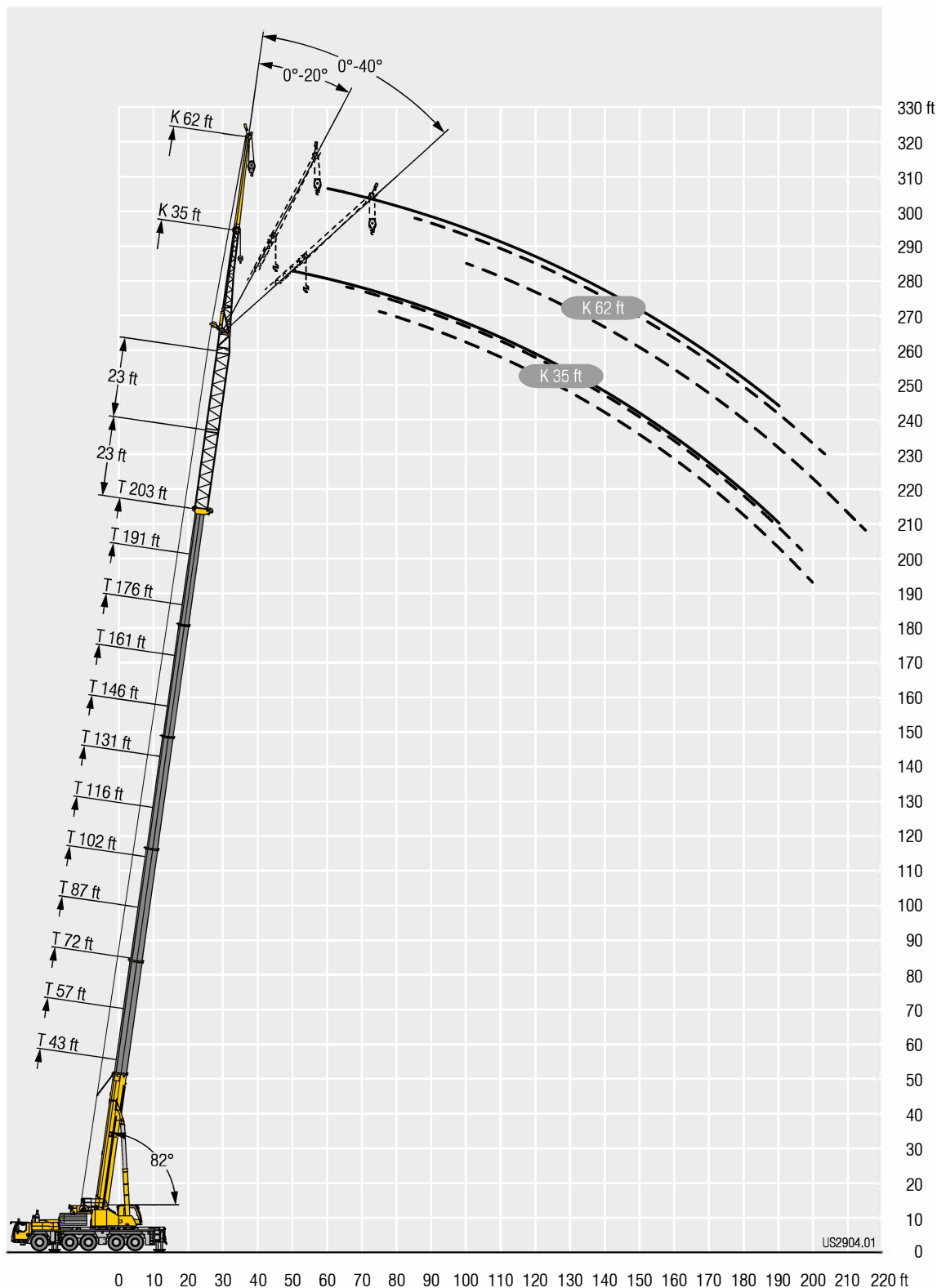

STERLING CRANE



LIFTING CHARTS - All Terrain Cranes

LIEBHERR MODEL LTM 1160-5.2 - 190 TON CAPACITY

Lifting capacities Forces de levage

TVNZK

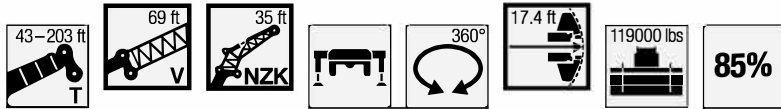

Jib ↙	43 ft + 69 ft			57 ft + 69 ft			72 ft + 69 ft			87 ft + 69 ft			102 ft + 69 ft			116 ft + 69 ft			Jib ↘
	35 ft			35 ft			35 ft			35 ft			35 ft			35 ft			
	0°	20°	40°	0°	20°	40°	0°	20°	40°	0°	20°	40°	0°	20°	40°	0°	20°	40°	
17	6.7																		17
18	6.8																		18
19	6.9			6.9															19
20	7			7															20
22	7.1			7.2			7												22
24	7.1			7.3			7.2			7.2									24
26	7.2			7.3			7.3			7.4			7.4						26
28	7.2	7.3		7.4			7.4			7.5			7.5						28
30	7.3	7.5		7.6			7.5			7.7			7.9			7.9			30
32	7.5	7.7		7.8	7.9		7.7			7.9			8.1			8.3			32
34	7.5	7.7		7.9	8.1		7.9	8.3		8.1			8.3			8.5			34
36	7.5	7.7		8.1	8.2		8.1	8.5		8.3	8.6		8.5			8.7			36
38	7.4	7.6	7.6	8	8.2		8.2	8.6		8.5	8.8		8.7			8.8			38
40	7.4	7.5	7.7	8	8.1	7.8	8.3	8.6		8.6	8.9		8.8	9.1		9			40
45	7.1	7.2	7.4	7.8	7.8	8	8.2	8.4	8.3	8.7	8.8	8.3	9	9.2		9.2	9.3		45
50	6.8	6.8	7	7.5	7.5	7.6	8.1	8.1	8.1	8.6	8.5	8.4	8.8	8.8	8.5	9.1	9		50
55	6.3	6.4	6.6	7.2	7.1	7.2	7.8	7.7	7.7	8.2	8.1	8	8.5	8.4	8.3	8.8	8.7	8.5	55
60	5.9	6	6.2	6.8	6.7	6.9	7.4	7.3	7.3	7.8	7.7	7.6	8.2	8	7.9	8.5	8.3	8.1	60
65	5.6	5.6	5.8	6.4	6.4	6.5	7	6.9	6.9	7.5	7.3	7.2	7.8	7.6	7.5	8.2	7.9	7.8	65
70	5.2	5.3	5.5	6	6	6.1	6.6	6.5	6.5	7.1	6.9	6.9	7.5	7.3	7.2	7.8	7.6	7.4	70
75	4.8	4.9	5.1	5.6	5.6	5.8	6.3	6.2	6.2	6.7	6.6	6.5	7.1	6.9	6.8	7.5	7.3	7.1	75
80	4.5	4.5	4.7	5.3	5.3	5.4	5.9	5.9	5.9	6.4	6.3	6.2	6.8	6.6	6.5	7.2	6.9	6.8	80
85	4.2	4.3	4.4	5	5	5.1	5.6	5.6	5.6	6.1	6	5.9	6.5	6.3	6.2	6.9	6.6	6.5	85
90	3.9	4	4.1	4.7	4.7	4.8	5.3	5.2	5.3	5.7	5.7	5.6	6.2	6	6	6.6	6.4	6.3	90
95	3.6	3.7	3.8	4.4	4.4	4.5	5	5	5	5.5	5.4	5.4	5.9	5.8	5.7	6.3	6.1	6	95
100	3.4	3.4	3.6	4.1	4.1	4.2	4.7	4.7	4.8	5.2	5.1	5.1	5.6	5.5	5.5	6	5.8	5.7	100
105	3.2	3.2	3.3	3.9	3.9	4	4.5	4.5	4.5	4.9	4.9	4.9	5.3	5.2	5.2	5.7	5.6	5.5	105
110	3	3	3.1	3.6	3.6	3.7	4.3	4.3	4.3	4.7	4.6	4.6	5.1	5	5	5.5	5.3	5.3	110
115	2.9	2.8	3	3.4	3.4	3.5	4	4	4.1	4.5	4.4	4.4	4.8	4.8	4.8	5.2	5.1	5.1	115
120	2.7	2.7	2.8	3.3	3.3	3.3	3.8	3.8	3.9	4.2	4.2	4.2	4.6	4.6	4.6	5	4.9	4.9	120
125	2.6	2.6	2.7	3.1	3.1	3.2	3.6	3.6	3.7	4	4	4.1	4.4	4.4	4.4	4.8	4.7	4.7	125
130	2.6	2.6	2.7	2.9	2.9		3.4	3.5	3.5	3.9	3.8	3.9	4.2	4.2	4.2	4.6	4.5	4.5	130
135	2.6	2.5	2.7	2.8	2.8		3.3	3.3	3.3	3.7	3.7	3.7	4	4	4	4.4	4.3	4.3	135
140	2.6	2.5		2.8	2.7		3.1	3.1	3.2	3.5	3.5	3.6	3.9	3.8	3.9	4.2	4.1	4.2	140
145				2.7	2.7		3	3		3.4	3.4	3.4	3.7	3.7	3.7	4	4	4	145
150				2.6	2.7		2.9	2.9		3.2	3.2	3.3	3.6	3.5	3.6	3.9	3.8	3.9	150
155				2.6			2.8	2.8		3.1	3.1		3.4	3.4	3.4	3.7	3.7	3.7	155
160							2.7	2.7		3	3		3.3	3.3	3.3	3.6	3.6	3.6	160
165							2.6			2.9	2.9		3.1	3.1		3.5	3.4	3.5	165
170							2.6			2.8	2.8		3	3		3.3	3.3	3.3	170
175										2.7	2.7		2.9	2.9		3.2	3.2	3.2	175
180										2.6			2.8	2.8		3.1	3.1		180
185										2.6			2.7	2.7		3	3		185
190													2.6	2.7		2.9	2.9		190
195																2.8	2.8		195
200																2.7	2.7		200
205																2.6	2.7		205
210																2.6			210



LIFTING CHARTS - All Terrain Cranes

LIEBHERR MODEL LTM 1160-5.2 - 190 TON CAPACITY

Lifting capacities Forces de levage

TVNZK



Lifting height (ft)	131 ft + 69 ft			146 ft + 69 ft			161 ft + 69 ft			176 ft + 69 ft			191 ft + 69 ft			203 ft + 69 ft			Lifting height (ft)
	0°	20°	40°	0°	20°	40°	0°	20°	40°	0°	20°	40°	0°	20°	40°	0°	20°	40°	
34	8.6																		34
36	8.8																		36
38	9			9.1															38
40	9.1			9.3															40
45	9.3			9.4			8.2												45
50	9.2	9.2		9.3	9.3		8.3			6.8									50
55	9	8.9	8.5	9.1	9.1		8.2	8.3		7			5.3			4			55
60	8.7	8.6	8.3	9	8.8	8.5	8.1	8.1		7.1	7.2		5.5			4.1			60
65	8.4	8.2	8	8.7	8.5	8.2	8	8	7.8	7	7.1		5.6	5.8		4.3			65
70	8.1	7.9	7.7	8.4	8.1	7.9	7.8	7.7	7.6	6.9	7	7	5.7	5.9		4.4	4.6		70
75	7.9	7.6	7.4	8.1	7.8	7.6	7.6	7.5	7.3	6.8	6.9	6.8	5.8	5.9	6	4.5	4.7		75
80	7.5	7.2	7.1	7.9	7.5	7.3	7.4	7.2	7	6.7	6.7	6.6	5.7	5.8	5.9	4.6	4.8	5	80
85	7.2	6.9	6.8	7.6	7.2	7	7.3	7	6.8	6.6	6.5	6.4	5.7	5.8	5.8	4.7	4.8	5	85
90	6.9	6.7	6.5	7.3	7	6.8	7	6.8	6.6	6.5	6.3	6.2	5.6	5.6	5.7	4.7	4.9	5	90
95	6.6	6.4	6.3	7	6.7	6.5	6.8	6.5	6.4	6.3	6.1	6	5.5	5.5	5.5	4.8	4.8	4.9	95
100	6.4	6.1	6	6.7	6.4	6.3	6.5	6.3	6.1	6.1	5.9	5.8	5.4	5.4	5.3	4.7	4.7	4.8	100
105	6.1	5.9	5.8	6.4	6.2	6.1	6.3	6.1	5.9	5.9	5.7	5.6	5.4	5.2	5.2	4.7	4.7	4.7	105
110	5.9	5.7	5.6	6.2	6	5.8	6.1	5.8	5.7	5.7	5.6	5.5	5.2	5.1	5	4.6	4.6	4.6	110
115	5.6	5.4	5.4	6	5.7	5.6	5.8	5.6	5.6	5.5	5.4	5.3	5.1	4.9	4.9	4.5	4.5	4.5	115
120	5.4	5.2	5.2	5.7	5.5	5.4	5.6	5.4	5.4	5.4	5.2	5.1	4.9	4.8	4.7	4.4	4.4	4.4	120
125	5.1	5	5	5.5	5.3	5.2	5.4	5.2	5.2	5.2	5	4.9	4.8	4.6	4.6	4.3	4.3	4.2	125
130	4.9	4.8	4.8	5.3	5.1	5.1	5.2	5.1	5	5	4.9	4.8	4.6	4.5	4.5	4.2	4.2	4.1	130
135	4.7	4.6	4.6	5.1	4.9	4.9	5	4.9	4.8	4.8	4.7	4.6	4.5	4.4	4.3	4.1	4	4	135
140	4.6	4.5	4.4	4.9	4.8	4.7	4.9	4.7	4.7	4.7	4.6	4.5	4.4	4.2	4.2	4	3.9	3.9	140
145	4.4	4.3	4.3	4.7	4.6	4.5	4.7	4.6	4.5	4.5	4.4	4.4	4.2	4.1	4.1	3.9	3.8	3.8	145
150	4.2	4.1	4.1	4.5	4.4	4.4	4.5	4.4	4.4	4.4	4.3	4.2	4.1	4	4	3.8	3.7	3.7	150
155	4	4	4	4.4	4.3	4.2	4.4	4.3	4.2	4.2	4.1	4.1	4	3.9	3.9	3.7	3.6	3.6	155
160	3.9	3.8	3.8	4.2	4.1	4.1	4.2	4.1	4.1	4.1	4	4	3.9	3.8	3.8	3.6	3.6	3.6	160
165	3.8	3.7	3.7	4	4	4	4.1	4	4	4	3.9	3.9	3.7	3.7	3.7	3.5	3.4	3.5	165
170	3.6	3.6	3.6	3.9	3.8	3.8	3.9	3.9	3.8	3.8	3.8	3.8	3.6	3.6	3.6	3.4	3.4	3.4	170
175	3.5	3.4	3.5	3.8	3.7	3.7	3.8	3.7	3.7	3.7	3.6	3.7	3.5	3.5	3.5	3.3	3.3	3.3	175
180	3.4	3.3	3.4	3.6	3.6	3.6	3.7	3.6	3.6	3.6	3.5	3.6	3.4	3.4	3.4	3.2	3.2	3.2	180
185	3.2	3.2	3.2	3.5	3.5	3.5	3.6	3.5	3.5	3.5	3.4	3.5	3.3	3.3	3.3		3.1	3.1	185
190	3.1	3.1		3.4	3.4	3.4	3.4	3.4	3.4	3.4	3.3	3.4	3.3	3.2	3.2	3	3.1		190
195	3	3		3.3	3.2	3.3	3.3	3.3	3.3	3.3	3.2	3.3		3.1	3.2		3		195
200	2.9	2.9		3.2	3.1		3.2	3.2	3.2	3.2	3.2	3.2			3.1				200
205	2.9	2.9		3.1	3		3.1	3.1	3.1	2.9	3.1	3.1							205
210	2.8	2.8		3	3		3	3	3.1		2.8	3							210
215	2.7	2.7		2.9	2.9		2.9	2.9				2.6							215
220	2.6	2.7		2.8	2.8		2.7	2.8											220
225	2.6			2.7	2.7		2	2.5											225
230				2.7	2.7														230
235				2.6															235
240				2.2															240



LIFTING CHARTS - All Terrain Cranes

LIEBHERR MODEL LTM 1160-5.2 - 190 TON CAPACITY

Lifting capacities Forces de levage

TVNZK

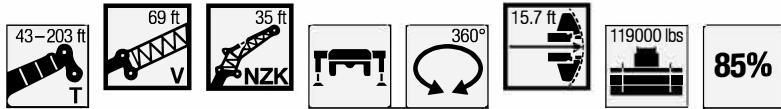

Lift Height (ft)	43 ft + 69 ft			57 ft + 69 ft			72 ft + 69 ft			87 ft + 69 ft			102 ft + 69 ft			116 ft + 69 ft			Lift Height (ft)
	35 ft			35 ft			35 ft			35 ft			35 ft			35 ft			
	0°	20°	40°	0°	20°	40°	0°	20°	40°	0°	20°	40°	0°	20°	40°	0°	20°	40°	
17	6.7																		17
18	6.8																		18
19	6.9			6.9															19
20	7			7															20
22	7.1			7.2			7												22
24	7.1			7.3			7.2			7.2									24
26	7.2			7.3			7.3			7.4			7.4						26
28	7.2	7.3		7.4			7.4			7.5			7.5						28
30	7.3	7.5		7.6			7.5			7.7			7.9			7.9			30
32	7.5	7.7		7.8	7.9		7.7			7.9			8.1			8.3			32
34	7.5	7.7		7.9	8.1		7.9	8.3		8.1			8.3			8.5			34
36	7.5	7.7		8.1	8.2		8.1	8.5		8.3	8.6		8.5			8.7			36
38	7.4	7.6	7.6	8	8.2		8.2	8.6		8.5	8.8		8.7			8.8			38
40	7.4	7.5	7.7	8	8.1	7.8	8.3	8.6		8.6	8.9		8.8	9.1		9			40
45	7.1	7.2	7.4	7.8	7.8	8	8.2	8.4	8.3	8.7	8.8	8.3	9	9.2		9.2	9.3		45
50	6.8	6.8	7	7.5	7.5	7.6	8.1	8.1	8.1	8.6	8.5	8.4	8.8	8.8	8.5	9.1	9		50
55	6.3	6.4	6.6	7.2	7.1	7.2	7.8	7.7	7.7	8.2	8.1	8	8.5	8.4	8.3	8.8	8.7	8.5	55
60	5.9	6	6.2	6.8	6.7	6.9	7.4	7.3	7.3	7.8	7.7	7.6	8.2	8	7.9	8.5	8.3	8.1	60
65	5.6	5.6	5.8	6.4	6.4	6.5	7	6.9	6.9	7.5	7.3	7.2	7.8	7.6	7.5	8.2	7.9	7.8	65
70	5.2	5.3	5.5	6	6	6.1	6.6	6.5	6.5	7.1	6.9	6.9	7.5	7.3	7.2	7.8	7.6	7.4	70
75	4.8	4.9	5.1	5.6	5.6	5.8	6.3	6.2	6.2	6.7	6.6	6.5	7.1	6.9	6.8	7.5	7.3	7.1	75
80	4.5	4.5	4.7	5.3	5.3	5.4	5.9	5.9	5.9	6.4	6.3	6.2	6.8	6.6	6.5	7.2	6.9	6.8	80
85	4.2	4.3	4.4	5	5	5.1	5.6	5.6	5.6	6.1	6	5.9	6.5	6.3	6.2	6.9	6.6	6.5	85
90	3.9	4	4.1	4.7	4.7	4.8	5.3	5.2	5.3	5.7	5.7	5.6	6.2	6	6	6.6	6.4	6.3	90
95	3.6	3.7	3.8	4.4	4.4	4.5	5	5	5	5.5	5.4	5.4	5.9	5.8	5.7	6.3	6.1	6	95
100	3.4	3.4	3.6	4.1	4.1	4.2	4.7	4.7	4.8	5.2	5.1	5.1	5.6	5.5	5.5	6	5.8	5.7	100
105	3.2	3.2	3.3	3.9	3.9	4	4.5	4.5	4.5	4.9	4.9	4.9	5.3	5.2	5.2	5.7	5.6	5.5	105
110	3	3	3.1	3.6	3.6	3.7	4.3	4.3	4.3	4.7	4.6	4.6	5.1	5	5	5.5	5.3	5.3	110
115	2.9	2.8	3	3.4	3.4	3.5	4	4	4.1	4.5	4.4	4.4	4.8	4.8	4.8	5.2	5.1	5.1	115
120	2.7	2.7	2.8	3.3	3.3	3.3	3.8	3.8	3.9	4.2	4.2	4.2	4.6	4.6	4.6	5	4.9	4.9	120
125	2.6	2.6	2.7	3.1	3.1	3.2	3.6	3.6	3.7	4	4	4.1	4.4	4.4	4.4	4.8	4.7	4.7	125
130	2.6	2.6	2.7	2.9	2.9		3.4	3.5	3.5	3.9	3.8	3.9	4.2	4.2	4.2	4.6	4.5	4.5	130
135	2.6	2.5	2.7	2.8	2.8		3.3	3.3	3.3	3.7	3.7	3.7	4	4	4	4.4	4.3	4.3	135
140	2.6	2.5		2.8	2.7		3.1	3.1	3.2	3.5	3.5	3.6	3.9	3.8	3.9	4.2	4.1	4.2	140
145				2.7	2.7		3	3		3.4	3.4	3.4	3.7	3.7	3.7	4	4	4	145
150				2.6	2.7		2.9	2.9		3.2	3.2	3.3	3.6	3.5	3.6	3.9	3.8	3.9	150
155				2.6			2.8	2.8		3.1	3.1		3.4	3.4	3.4	3.7	3.7	3.7	155
160							2.7	2.7		3	3		3.3	3.3	3.3	3.6	3.6	3.6	160
165							2.6			2.9	2.9		3.1	3.1		3.5	3.4	3.5	165
170							2.6			2.8	2.8		3	3		3.3	3.3	3.3	170
175										2.7	2.7		2.9	2.9		3.2	3.2	3.2	175
180										2.6			2.8	2.8		3.1	3.1		180
185										2.6			2.7	2.7		3	3		185
190													2.6	2.7		2.9	2.9		190
195																2.8	2.8		195
200																2.7	2.7		200
205																2.6	2.7		205
210																2.6			210



LIFTING CHARTS - All Terrain Cranes

LIEBHERR MODEL LTM 1160-5.2 - 190 TON CAPACITY

Lifting capacities Forces de levage

TVNZK



Lift Height (ft)	131 ft + 69 ft			146 ft + 69 ft			161 ft + 69 ft			176 ft + 69 ft			191 ft + 69 ft			203 ft + 69 ft			Lift Height (ft)
	0°	20°	40°	0°	20°	40°	0°	20°	40°	0°	20°	40°	0°	20°	40°	0°	20°	40°	
34	8.6																		34
36	8.8																		36
38	9			9.1															38
40	9.1			9.3															40
45	9.3			9.4			8.2												45
50	9.2	9.2		9.3	9.3		8.3			6.8									50
55	9	8.9	8.5	9.1	9.1		8.2	8.3		7			5.3			4			55
60	8.7	8.6	8.3	9	8.8	8.5	8.1	8.1		7.1	7.2		5.5			4.1			60
65	8.4	8.2	8	8.7	8.5	8.2	8	8	7.8	7	7.1		5.6	5.8		4.3			65
70	8.1	7.9	7.7	8.4	8.1	7.9	7.8	7.7	7.6	6.9	7	7	5.7	5.9		4.4	4.6		70
75	7.9	7.6	7.4	8.1	7.8	7.6	7.6	7.5	7.3	6.8	6.9	6.8	5.8	5.9	6	4.5	4.7		75
80	7.5	7.2	7.1	7.9	7.5	7.3	7.4	7.2	7	6.7	6.7	6.6	5.7	5.8	5.9	4.6	4.8	5	80
85	7.2	6.9	6.8	7.6	7.2	7	7.3	7	6.8	6.6	6.5	6.4	5.7	5.8	5.8	4.7	4.8	5	85
90	6.9	6.7	6.5	7.3	7	6.8	7	6.8	6.6	6.5	6.3	6.2	5.6	5.6	5.7	4.7	4.9	5	90
95	6.6	6.4	6.3	7	6.7	6.5	6.8	6.5	6.4	6.3	6.1	6	5.5	5.5	5.5	4.8	4.8	4.9	95
100	6.4	6.1	6	6.7	6.4	6.3	6.5	6.3	6.1	6.1	5.9	5.8	5.4	5.4	5.3	4.7	4.7	4.8	100
105	6.1	5.9	5.8	6.4	6.2	6.1	6.3	6.1	5.9	5.9	5.7	5.6	5.4	5.2	5.2	4.7	4.7	4.7	105
110	5.9	5.7	5.6	6.2	6	5.8	6.1	5.8	5.7	5.7	5.6	5.5	5.2	5.1	5	4.6	4.6	4.6	110
115	5.6	5.4	5.4	6	5.7	5.6	5.8	5.6	5.6	5.5	5.4	5.3	5.1	4.9	4.9	4.5	4.5	4.5	115
120	5.4	5.2	5.2	5.7	5.5	5.4	5.6	5.4	5.4	5.4	5.2	5.1	4.9	4.8	4.7	4.4	4.4	4.4	120
125	5.1	5	5	5.5	5.3	5.2	5.4	5.2	5.2	5.2	5	4.9	4.8	4.6	4.6	4.3	4.3	4.2	125
130	4.9	4.8	4.8	5.3	5.1	5.1	5.2	5.1	5	5	4.9	4.8	4.6	4.5	4.5	4.2	4.2	4.1	130
135	4.7	4.6	4.6	5.1	4.9	4.9	5	4.9	4.8	4.8	4.7	4.6	4.5	4.4	4.3	4.1	4	4	135
140	4.6	4.5	4.4	4.9	4.8	4.7	4.9	4.7	4.7	4.7	4.6	4.5	4.4	4.2	4.2	4	3.9	3.9	140
145	4.4	4.3	4.3	4.7	4.6	4.5	4.7	4.6	4.5	4.5	4.4	4.4	4.2	4.1	4.1	3.9	3.8	3.8	145
150	4.2	4.1	4.1	4.5	4.4	4.4	4.5	4.4	4.4	4.4	4.3	4.2	4.1	4	4	3.8	3.7	3.7	150
155	4	4	4	4.4	4.3	4.2	4.4	4.3	4.2	4.2	4.1	4.1	4	3.9	3.9	3.7	3.6	3.6	155
160	3.9	3.8	3.8	4.2	4.1	4.1	4.2	4.1	4.1	4.1	4	4	3.9	3.8	3.8	3.6	3.6	3.6	160
165	3.8	3.7	3.7	4	4	4	4.1	4	4	4	3.9	3.9	3.7	3.7	3.7	3.5	3.4	3.5	165
170	3.6	3.6	3.6	3.9	3.8	3.8	3.9	3.9	3.8	3.8	3.8	3.8	3.6	3.6	3.6	3.4	3.4	3.4	170
175	3.5	3.4	3.5	3.8	3.7	3.7	3.8	3.7	3.7	3.7	3.6	3.7	3.5	3.5	3.5	3.3	3.3	3.3	175
180	3.4	3.3	3.4	3.6	3.6	3.6	3.7	3.6	3.6	3.6	3.5	3.6	3.4	3.4	3.4	3.2	3.2	3.2	180
185	3.2	3.2	3.2	3.5	3.5	3.5	3.6	3.5	3.5	3.5	3.4	3.5	3.3	3.3	3.3		3.1	3.1	185
190	3.1	3.1		3.4	3.4	3.4	3.4	3.4	3.4	3.4	3.3	3.4	3.3	3.2	3.2	3	3.1		190
195	3	3		3.3	3.2	3.3	3.3	3.3	3.3	3.3	3.2	3.3		3.1	3.2		3		195
200	2.9	2.9		3.2	3.1		3.2	3.2	3.2	3.1	3.2	3.2			3.1				200
205	2.9	2.9		3.1	3		3.1	3.1	3.1	2.7	3	3.1							205
210	2.8	2.8		3	3		3	3	3.1		2.7	2.9							210
215	2.7	2.7		2.9	2.9		2.8	2.9				2.3							215
220	2.6	2.7		2.8	2.8		2.6	2.8											220
225	2.6			2.7	2.7			2.4											225
230				2.7	2.7														230
235				2.6															235
240				1.8															240



LIFTING CHARTS - All Terrain Cranes

LIEBHERR MODEL LTM 1160-5.2 - 190 TON CAPACITY

Lifting capacities Forces de levage

TVNZK

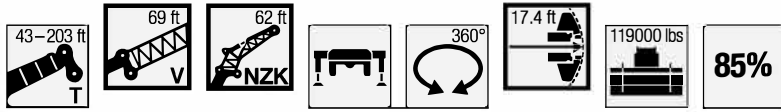

Lift Height (ft)	43 ft + 69 ft			57 ft + 69 ft			72 ft + 69 ft			87 ft + 69 ft			102 ft + 69 ft			116 ft + 69 ft			Lift Height (ft)
	0°	20°	40°	0°	20°	40°	0°	20°	40°	0°	20°	40°	0°	20°	40°	0°	20°	40°	
22	6.7																		22
24	6.7			6.7															24
26	6.6			6.7			6.7												26
28	6.5			6.6			6.7			6.7									28
30	6.5			6.6			6.6			6.7									30
32	6.4			6.5			6.6			6.7			6.7						32
34	6.4			6.5			6.5			6.6			6.7						34
36	6.3			6.4			6.5			6.6			6.6			6.7			36
38	6.3			6.4			6.4			6.5			6.6			6.6			38
40	6.2			6.3			6.4			6.5			6.5			6.6			40
45	6	6.3		6.1			6.3			6.3			6.4			6.5			45
50	5.8	6.1		6	6.3		6.1	6.3		6.2			6.3			6.4			50
55	5.5	5.8		5.8	6		5.9	6.2		6.1	6.3		6.2	6.3		6.3			55
60	5.2	5.4	5.4	5.6	5.7		5.8	5.9		5.9	6.1		6.1	6.2		6.2	6.3		60
65	4.9	5.1	5.3	5.2	5.4	5.4	5.6	5.6	5.4	5.8	5.8		5.9	6		6	6.1		65
70	4.5	4.7	5	4.9	5	5.2	5.3	5.3	5.3	5.6	5.5	5.4	5.8	5.7	5.4	5.9	5.9		70
75	4.3	4.5	4.7	4.6	4.7	4.9	5	5	5.1	5.3	5.3	5.2	5.6	5.5	5.3	5.8	5.7	5.4	75
80	4	4.2	4.4	4.4	4.5	4.6	4.7	4.7	4.8	5	5	5	5.3	5.2	5.1	5.6	5.4	5.3	80
85	3.7	3.9	4.1	4.1	4.2	4.4	4.4	4.5	4.6	4.8	4.7	4.8	5.1	5	4.9	5.4	5.2	5.1	85
90	3.5	3.7	3.9	3.9	4	4.1	4.2	4.3	4.3	4.5	4.5	4.5	4.8	4.7	4.7	5.1	5	4.9	90
95	3.3	3.4	3.6	3.6	3.7	3.9	4	4	4.1	4.3	4.3	4.3	4.6	4.5	4.5	4.9	4.7	4.7	95
100	3.1	3.2	3.4	3.4	3.5	3.7	3.8	3.8	3.9	4.1	4.1	4.1	4.4	4.3	4.3	4.6	4.5	4.5	100
105	2.9	3	3.2	3.2	3.3	3.5	3.6	3.6	3.7	3.9	3.9	3.9	4.2	4.1	4.1	4.4	4.3	4.3	105
110	2.7	2.8	3	3	3.1	3.2	3.4	3.4	3.5	3.7	3.7	3.7	4	3.9	3.9	4.2	4.1	4.1	110
115	2.5	2.7	2.8	2.9	3	3.1	3.2	3.2	3.3	3.5	3.5	3.6	3.8	3.7	3.8	4.1	4	3.9	115
120	2.4	2.5	2.6	2.7	2.8	2.9	3	3.1	3.1	3.3	3.3	3.4	3.6	3.6	3.6	3.9	3.8	3.8	120
125	2.2	2.3	2.5	2.5	2.6	2.7	2.8	2.9	3	3.1	3.2	3.2	3.4	3.4	3.4	3.7	3.6	3.6	125
130	2.1	2.2	2.3	2.4	2.5	2.6	2.7	2.7	2.8	3	3	3.1	3.2	3.2	3.3	3.5	3.5	3.5	130
135	2	2	2.2	2.2	2.3	2.4	2.5	2.6	2.7	2.8	2.9	2.9	3.1	3.1	3.1	3.4	3.3	3.3	135
140	1.8	1.9	2	2.1	2.2	2.3	2.4	2.5	2.5	2.7	2.7	2.8	2.9	3	3	3.2	3.2	3.2	140
145	1.7	1.8	1.9	2	2.1	2.2	2.3	2.3	2.4	2.5	2.6	2.6	2.8	2.8	2.9	3.1	3	3	145
150	1.6	1.7	1.8	1.9	1.9	2	2.1	2.2	2.3	2.4	2.5	2.5	2.7	2.7	2.7	2.9	2.9	2.9	150
155	1.5	1.6	1.7	1.8	1.8	1.9	2	2.1	2.2	2.3	2.3	2.4	2.5	2.6	2.6	2.8	2.8	2.8	155
160	1.5	1.5	1.7	1.7	1.7	1.8	1.9	2	2.1	2.2	2.2	2.3	2.4	2.4	2.5	2.7	2.7	2.7	160
165	1.4	1.5		1.6	1.7		1.8	1.9	2	2.1	2.1	2.2	2.3	2.3	2.4	2.5	2.5	2.6	165
170				1.5	1.6		1.7	1.8	1.9	2	2	2.1	2.2	2.2	2.3	2.4	2.4	2.5	170
175				1.5	1.5		1.7	1.7		1.9	1.9	2	2.1	2.1	2.2	2.3	2.3	2.4	175
180				1.4			1.6	1.6		1.8	1.8	1.9	2	2	2.1	2.2	2.2	2.3	180
185							1.5	1.6		1.7	1.7	1.8	1.9	1.9	2	2.1	2.1	2.2	185
190							1.5	1.5		1.6	1.7		1.8	1.9	1.9	2	2	2.1	190
195							1.4			1.6	1.6		1.7	1.8	1.8	1.9	2	2	195
200										1.5	1.5		1.7	1.7		1.9	1.9	1.9	200
205										1.5	1.5		1.6	1.6		1.8	1.8	1.9	205
210										1.4			1.5	1.6		1.7	1.7	1.8	210
215													1.5	1.5		1.7	1.7		215
220													1.5	1.5		1.6	1.6		220
225													1.4			1.5	1.6		225
230																1.5	1.5		230
235																1.4	1.5		235
240																1.4			240



LIFTING CHARTS - All Terrain Cranes

LIEBHERR MODEL LTM 1160-5.2 - 190 TON CAPACITY

Lifting capacities Forces de levage

TVNZK



Lifting height (ft)	131 ft + 69 ft			146 ft + 69 ft			161 ft + 69 ft			176 ft + 69 ft			191 ft + 69 ft			203 ft + 69 ft			Lifting height (ft)
	0°	20°	40°	0°	20°	40°	0°	20°	40°	0°	20°	40°	0°	20°	40°	0°	20°	40°	
38	6.7																		38
40	6.7																		40
45	6.6			5.4															45
50	6.4			5.7			4.6												50
55	6.4			5.8			4.9			3.9									55
60	6.3			6			5			3.9			3.1						60
65	6.1	6.3		6.1			5.1			4.1			3.1			2.5			65
70	6	6		6.1	6.2		5.2			4.2			3.1			2.6			70
75	5.9	5.8		6	6		5.3	5.5		4.3			3.2			2.6			75
80	5.8	5.6	5.3	5.9	5.8		5.3	5.4		4.3	4.6		3.2			2.6			80
85	5.6	5.4	5.2	5.8	5.5	5.3	5.3	5.3		4.4	4.6		3.3	3.5		2.6			85
90	5.4	5.2	5	5.6	5.3	5.1	5.2	5.1	5	4.4	4.6		3.4	3.6		2.6	2.8		90
95	5.1	4.9	4.8	5.4	5.1	5	5.1	4.9	4.8	4.5	4.6	4.5	3.4	3.6		2.6	2.8		95
100	4.9	4.7	4.6	5.2	4.9	4.8	5	4.8	4.6	4.5	4.4	4.3	3.5	3.6	3.8	2.7	2.9		100
105	4.7	4.5	4.5	5	4.7	4.6	4.8	4.6	4.5	4.4	4.3	4.2	3.5	3.6	3.7	2.7	2.9	3.1	105
110	4.5	4.4	4.3	4.8	4.5	4.4	4.6	4.4	4.3	4.3	4.1	4.1	3.5	3.6	3.6	2.8	3	3.1	110
115	4.3	4.2	4.1	4.5	4.4	4.3	4.4	4.3	4.1	4.1	4	3.9	3.5	3.5	3.5	2.8	2.9	3.1	115
120	4.1	4	4	4.4	4.2	4.1	4.3	4.1	4	4	3.9	3.8	3.4	3.4	3.4	2.8	2.9	3	120
125	4	3.8	3.8	4.2	4	4	4.1	4	3.9	3.9	3.8	3.7	3.4	3.3	3.3	2.8	2.9	3	125
130	3.8	3.7	3.7	4	3.9	3.8	3.9	3.8	3.7	3.7	3.6	3.6	3.3	3.3	3.2	2.8	2.9	2.9	130
135	3.6	3.5	3.5	3.9	3.7	3.7	3.8	3.7	3.6	3.6	3.5	3.5	3.2	3.2	3.1	2.7	2.8	2.8	135
140	3.5	3.4	3.4	3.7	3.6	3.6	3.6	3.5	3.5	3.5	3.4	3.3	3.1	3.1	3	2.7	2.7	2.7	140
145	3.3	3.2	3.2	3.6	3.4	3.4	3.5	3.4	3.4	3.4	3.2	3.2	3	2.9	2.9	2.6	2.6	2.7	145
150	3.2	3.1	3.1	3.4	3.3	3.3	3.4	3.3	3.2	3.2	3.1	3.1	2.9	2.8	2.9	2.6	2.6	2.6	150
155	3	3	3	3.3	3.2	3.2	3.2	3.1	3.1	3.1	3	3	2.8	2.7	2.8	2.5	2.5	2.5	155
160	2.9	2.9	2.9	3.1	3.1	3	3.1	3	3	3	2.9	2.9	2.7	2.6	2.7	2.4	2.4	2.4	160
165	2.8	2.7	2.8	3	3	2.9	3	2.9	2.9	2.9	2.8	2.8	2.6	2.5	2.6	2.4	2.3	2.3	165
170	2.7	2.6	2.7	2.9	2.8	2.8	2.9	2.8	2.8	2.8	2.7	2.7	2.5	2.4	2.5	2.3	2.2	2.3	170
175	2.5	2.5	2.6	2.8	2.7	2.7	2.8	2.7	2.7	2.7	2.6	2.6	2.4	2.4	2.4	2.2	2.2	2.2	175
180	2.4	2.4	2.5	2.7	2.6	2.6	2.7	2.6	2.6	2.6	2.5	2.5	2.3	2.3	2.3	2.1	2.1	2.1	180
185	2.3	2.3	2.4	2.5	2.5	2.5	2.6	2.5	2.5	2.5	2.4	2.4	2.2	2.2	2.3	2	2	2.1	185
190	2.2	2.2	2.3	2.4	2.4	2.4	2.5	2.4	2.4	2.4	2.3	2.3	2.2	2.1	2.2		1.9	2	190
195	2.1	2.1	2.2	2.3	2.3	2.3	2.3	2.3	2.3	2.3	2.2	2.2		2	2.1		1.9	1.9	195
200	2.1	2.1	2.1	2.2	2.2	2.2	2.2	2.2	2.2	2.2	2.1	2.2		1.9	2		1.8	1.9	200
205	2	2	2	2.1	2.1	2.1	2.1	2.1	2.1	2.1	2	2.1		1.9	1.9				205
210	1.9	1.9	2	2	2	2	2	2	2.1		2	2			1.9				210
215	1.8	1.8	1.9	1.9	1.9	2	2	1.9	2		1.9	1.9							215
220	1.7	1.7	1.8	1.8	1.8	1.9	1.8	1.8	1.9			1.9							220
225	1.7	1.7		1.8	1.7	1.8	1.6	1.8	1.9			1.8							225
230	1.6	1.6		1.7	1.7	1.8	1.3	1.7	1.8										230
235	1.6	1.6		1.6	1.6				1.6										235
240	1.5	1.5		1.5	1.6														240
245	1.5	1.5		1.3	1.5														245
250	1.4	1.5			1.3														250
255	1.4																		255



LIFTING CHARTS - All Terrain Cranes

LIEBHERR MODEL LTM 1160-5.2 - 190 TON CAPACITY

Lifting capacities Forces de levage

TVNZK

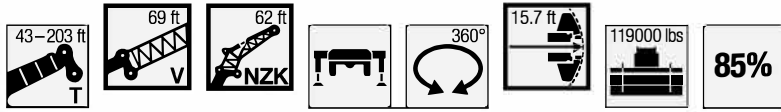

Lift Height (ft)	43 ft + 69 ft			57 ft + 69 ft			72 ft + 69 ft			87 ft + 69 ft			102 ft + 69 ft			116 ft + 69 ft			Lift Height (ft)
	0°	20°	40°	0°	20°	40°	0°	20°	40°	0°	20°	40°	0°	20°	40°	0°	20°	40°	
22	6.7			6.7															22
24	6.7			6.7															24
26	6.6			6.7			6.7												26
28	6.5			6.6			6.7			6.7									28
30	6.5			6.6			6.6			6.7									30
32	6.4			6.5			6.6			6.7			6.7						32
34	6.4			6.5			6.5			6.6			6.7						34
36	6.3			6.4			6.5			6.6			6.6			6.7			36
38	6.3			6.4			6.4			6.5			6.6			6.6			38
40	6.2			6.3			6.4			6.5			6.5			6.6			40
45	6	6.3		6.1			6.3			6.3			6.4			6.5			45
50	5.8	6.1		6	6.3		6.1	6.3		6.2			6.3			6.4			50
55	5.5	5.8		5.8	6		5.9	6.2		6.1	6.3		6.2	6.3		6.3			55
60	5.2	5.4	5.4	5.6	5.7		5.8	5.9		5.9	6.1		6.1	6.2		6.2	6.3		60
65	4.9	5.1	5.3	5.2	5.4	5.4	5.6	5.6	5.4	5.8	5.8		5.9	6		6	6.1		65
70	4.5	4.7	5	4.9	5	5.2	5.3	5.3	5.3	5.6	5.5	5.4	5.8	5.7	5.4	5.9	5.9		70
75	4.3	4.5	4.7	4.6	4.7	4.9	5	5	5.1	5.3	5.3	5.2	5.6	5.5	5.3	5.8	5.7	5.4	75
80	4	4.2	4.4	4.4	4.5	4.6	4.7	4.7	4.8	5	5	5	5.3	5.2	5.1	5.6	5.4	5.3	80
85	3.7	3.9	4.1	4.1	4.2	4.4	4.4	4.5	4.6	4.8	4.7	4.8	5.1	5	4.9	5.4	5.2	5.1	85
90	3.5	3.7	3.9	3.9	4	4.1	4.2	4.3	4.3	4.5	4.5	4.5	4.8	4.7	4.7	5.1	5	4.9	90
95	3.3	3.4	3.6	3.6	3.7	3.9	4	4	4.1	4.3	4.3	4.3	4.6	4.5	4.5	4.9	4.7	4.7	95
100	3.1	3.2	3.4	3.4	3.5	3.7	3.8	3.8	3.9	4.1	4.1	4.1	4.4	4.3	4.3	4.6	4.5	4.5	100
105	2.9	3	3.2	3.2	3.3	3.5	3.6	3.6	3.7	3.9	3.9	3.9	4.2	4.1	4.1	4.4	4.3	4.3	105
110	2.7	2.8	3	3	3.1	3.2	3.4	3.4	3.5	3.7	3.7	3.7	4	3.9	3.9	4.2	4.1	4.1	110
115	2.5	2.7	2.8	2.9	3	3.1	3.2	3.2	3.3	3.5	3.5	3.6	3.8	3.7	3.8	4.1	4	3.9	115
120	2.4	2.5	2.6	2.7	2.8	2.9	3	3.1	3.1	3.3	3.3	3.4	3.6	3.6	3.6	3.9	3.8	3.8	120
125	2.2	2.3	2.5	2.5	2.6	2.7	2.8	2.9	3	3.1	3.2	3.2	3.4	3.4	3.4	3.7	3.6	3.6	125
130	2.1	2.2	2.3	2.4	2.5	2.6	2.7	2.7	2.8	3	3	3.1	3.2	3.2	3.3	3.5	3.5	3.5	130
135	2	2	2.2	2.2	2.3	2.4	2.5	2.6	2.7	2.8	2.9	2.9	3.1	3.1	3.1	3.4	3.3	3.3	135
140	1.8	1.9	2	2.1	2.2	2.3	2.4	2.5	2.5	2.7	2.7	2.8	2.9	3	3	3.2	3.2	3.2	140
145	1.7	1.8	1.9	2	2.1	2.2	2.3	2.3	2.4	2.5	2.6	2.6	2.8	2.8	2.9	3.1	3	3	145
150	1.6	1.7	1.8	1.9	1.9	2	2.1	2.2	2.3	2.4	2.5	2.5	2.7	2.7	2.7	2.9	2.9	2.9	150
155	1.5	1.6	1.7	1.8	1.8	1.9	2	2.1	2.2	2.3	2.3	2.4	2.5	2.6	2.6	2.8	2.8	2.8	155
160	1.5	1.5	1.7	1.7	1.7	1.8	1.9	2	2.1	2.2	2.2	2.3	2.4	2.4	2.5	2.7	2.7	2.7	160
165	1.4	1.5		1.6	1.7		1.8	1.9	2	2.1	2.1	2.2	2.3	2.3	2.4	2.5	2.5	2.6	165
170				1.5	1.6		1.7	1.8	1.9	2	2	2.1	2.2	2.2	2.3	2.4	2.4	2.5	170
175				1.5	1.5		1.7	1.7		1.9	1.9	2	2.1	2.1	2.2	2.3	2.3	2.4	175
180				1.4			1.6	1.6		1.8	1.8	1.9	2	2	2.1	2.2	2.2	2.3	180
185							1.5	1.6		1.7	1.7	1.8	1.9	1.9	2	2.1	2.1	2.2	185
190							1.5	1.5		1.6	1.7		1.8	1.9	1.9	2	2	2.1	190
195							1.4			1.6	1.6		1.7	1.8	1.8	1.9	2	2	195
200										1.5	1.5		1.7	1.7		1.9	1.9	1.9	200
205										1.5	1.5		1.6	1.6		1.8	1.8	1.9	205
210										1.4			1.5	1.6		1.7	1.7	1.8	210
215													1.5	1.5		1.7	1.7		215
220													1.5	1.5		1.6	1.6		220
225													1.4			1.5	1.6		225
230																1.5	1.5		230
235																1.4	1.5		235
240																1.4			240

STERLING CRANE



LIFTING CHARTS - All Terrain Cranes

LIEBHERR MODEL LTM 1160-5.2 - 190 TON CAPACITY

Lifting capacities Forces de levage

TVNZK



Lift Height (ft)	131 ft + 69 ft			146 ft + 69 ft			161 ft + 69 ft			176 ft + 69 ft			191 ft + 69 ft			203 ft + 69 ft			Lift Height (ft)
	0°	20°	40°	0°	20°	40°	0°	20°	40°	0°	20°	40°	0°	20°	40°	0°	20°	40°	
38	6.7																		38
40	6.7																		40
45	6.6			5.4															45
50	6.4			5.7			4.6												50
55	6.4			5.8			4.9			3.9									55
60	6.3			6			5			3.9			3.1						60
65	6.1	6.3		6.1			5.1			4.1			3.1			2.5			65
70	6	6		6.1	6.2		5.2			4.2			3.1			2.6			70
75	5.9	5.8		6	6		5.3	5.5		4.3			3.2			2.6			75
80	5.8	5.6	5.3	5.9	5.8		5.3	5.4		4.3	4.6		3.2			2.6			80
85	5.6	5.4	5.2	5.8	5.5	5.3	5.3	5.3		4.4	4.6		3.3	3.5		2.6			85
90	5.4	5.2	5	5.6	5.3	5.1	5.2	5.1	5	4.4	4.6		3.4	3.6		2.6	2.8		90
95	5.1	4.9	4.8	5.4	5.1	5	5.1	4.9	4.8	4.5	4.6	4.5	3.4	3.6		2.6	2.8		95
100	4.9	4.7	4.6	5.2	4.9	4.8	5	4.8	4.6	4.5	4.4	4.3	3.5	3.6	3.8	2.7	2.9		100
105	4.7	4.5	4.5	5	4.7	4.6	4.8	4.6	4.5	4.4	4.3	4.2	3.5	3.6	3.7	2.7	2.9	3.1	105
110	4.5	4.4	4.3	4.8	4.5	4.4	4.6	4.4	4.3	4.3	4.1	4.1	3.5	3.6	3.6	2.8	3	3.1	110
115	4.3	4.2	4.1	4.5	4.4	4.3	4.4	4.3	4.1	4.1	4	3.9	3.5	3.5	3.5	2.8	2.9	3.1	115
120	4.1	4	4	4.4	4.2	4.1	4.3	4.1	4	4	3.9	3.8	3.4	3.4	3.4	2.8	2.9	3	120
125	4	3.8	3.8	4.2	4	4	4.1	4	3.9	3.9	3.8	3.7	3.4	3.3	3.3	2.8	2.9	3	125
130	3.8	3.7	3.7	4	3.9	3.8	3.9	3.8	3.7	3.7	3.6	3.6	3.3	3.3	3.2	2.8	2.9	2.9	130
135	3.6	3.5	3.5	3.9	3.7	3.7	3.8	3.7	3.6	3.6	3.5	3.5	3.2	3.2	3.1	2.7	2.8	2.8	135
140	3.5	3.4	3.4	3.7	3.6	3.6	3.6	3.5	3.5	3.5	3.4	3.3	3.1	3.1	3	2.7	2.7	2.7	140
145	3.3	3.2	3.2	3.6	3.4	3.4	3.5	3.4	3.4	3.4	3.2	3.2	3	2.9	2.9	2.6	2.6	2.7	145
150	3.2	3.1	3.1	3.4	3.3	3.3	3.4	3.3	3.2	3.2	3.1	3.1	2.9	2.8	2.9	2.6	2.6	2.6	150
155	3	3	3	3.3	3.2	3.2	3.2	3.1	3.1	3.1	3	3	2.8	2.7	2.8	2.5	2.5	2.5	155
160	2.9	2.9	2.9	3.1	3.1	3	3.1	3	3	3	2.9	2.9	2.7	2.6	2.7	2.4	2.4	2.4	160
165	2.8	2.7	2.8	3	3	2.9	3	2.9	2.9	2.9	2.8	2.8	2.6	2.5	2.6	2.4	2.3	2.3	165
170	2.7	2.6	2.7	2.9	2.8	2.8	2.9	2.8	2.8	2.8	2.7	2.7	2.5	2.4	2.5	2.3	2.2	2.3	170
175	2.5	2.5	2.6	2.8	2.7	2.7	2.8	2.7	2.7	2.7	2.6	2.6	2.4	2.4	2.4	2.2	2.2	2.2	175
180	2.4	2.4	2.5	2.7	2.6	2.6	2.7	2.6	2.6	2.6	2.5	2.5	2.3	2.3	2.3	2.1	2.1	2.1	180
185	2.3	2.3	2.4	2.5	2.5	2.5	2.6	2.5	2.5	2.5	2.4	2.4	2.2	2.2	2.3	2	2	2.1	185
190	2.2	2.2	2.3	2.4	2.4	2.4	2.5	2.4	2.4	2.4	2.3	2.3	2.2	2.1	2.2		1.9	2	190
195	2.1	2.1	2.2	2.3	2.3	2.3	2.3	2.3	2.3	2.3	2.2	2.2		2	2.1			1.9	195
200	2.1	2.1	2.1	2.2	2.2	2.2	2.2	2.2	2.2	2.2	2.1	2.2		1.9	2			1.9	200
205	2	2	2	2.1	2.1	2.1	2.1	2.1	2.1	2.1	2	2.1		1.9	1.9				205
210	1.9	1.9	2	2	2	2	2	2	2.1		2	2			1.9				210
215	1.8	1.8	1.9	1.9	1.9	2	2	1.9	2		1.8	1.9							215
220	1.7	1.7	1.8	1.8	1.8	1.9	1.8	1.8	1.9			1.8							220
225	1.7	1.7		1.8	1.7	1.8		1.8	1.9			1.7							225
230	1.6	1.6		1.7	1.7	1.8		1.6	1.8										230
235	1.6	1.6		1.6	1.6				1.6										235
240	1.5	1.5		1.5	1.6														240
245	1.5	1.5			1.5														245
250	1.4	1.5																	250
255	1.4																		255



LIFTING CHARTS - All Terrain Cranes

LIEBHERR MODEL LTM 1160-5.2 - 190 TON CAPACITY

TVNZK

Lifting heights Hauteurs de levage

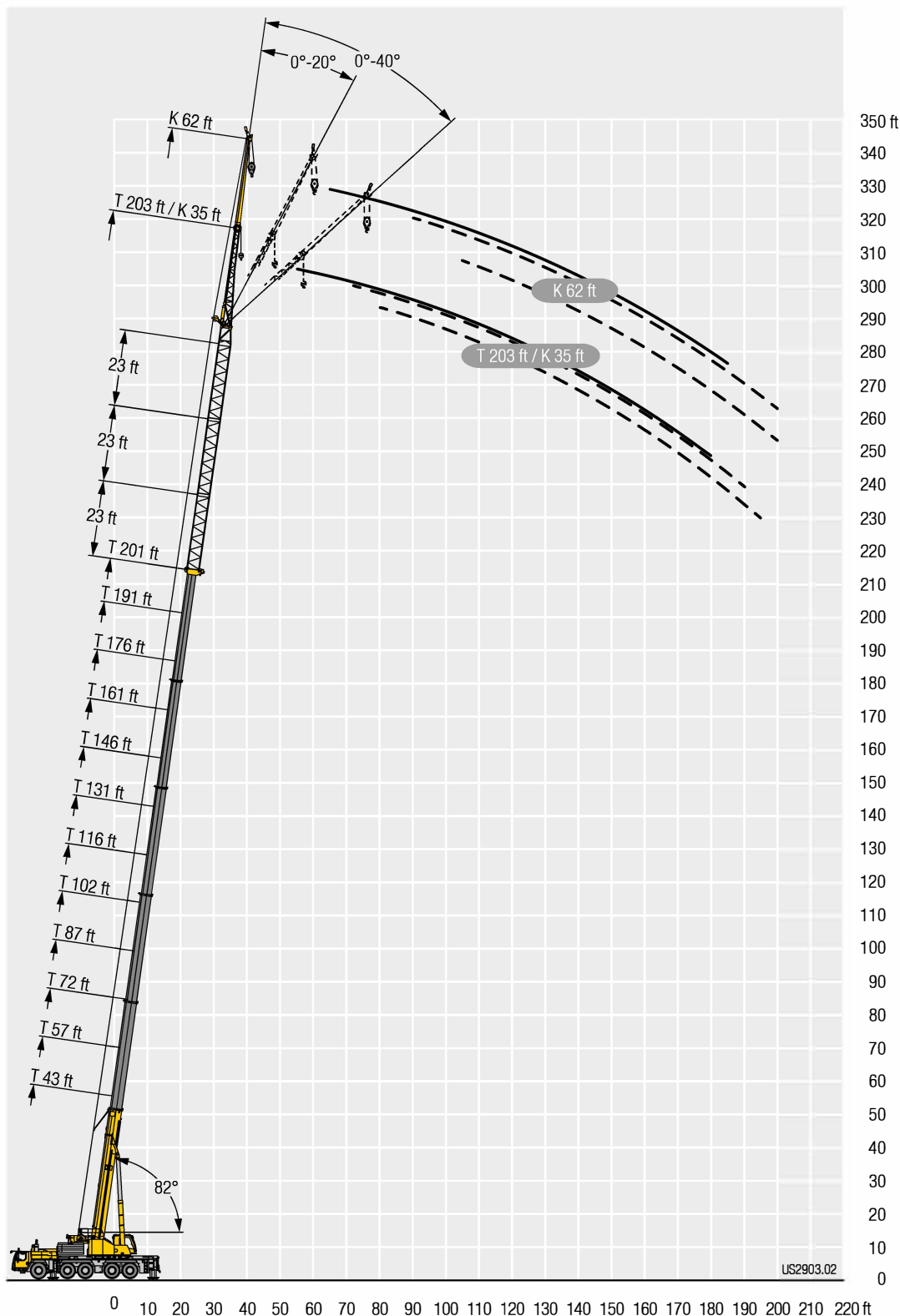



LIFTING CHARTS - All Terrain Cranes

LIEBHERR MODEL LTM 1160-5.2 - 190 TON CAPACITY

Lifting capacities Forces de levage

TK

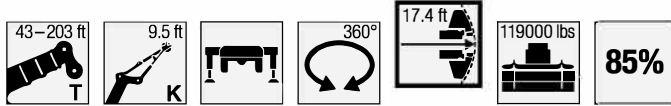

43 ft	57 ft	72 ft	87 ft	102 ft	116 ft	131 ft	146 ft	161 ft	176 ft	191 ft	203 ft	9.5 ft	
													43 ft
10	76.2	76.2										10	
11	76.2	76.2										11	
12	76.2	76.2	76.2									12	
13	76.2	76.2	76.2									13	
14	76.2	76.2	76.2	76.2								14	
15	76.2	76.2	76.2	76.2								15	
16	76.2	76.2	76.2	76.2								16	
17	76.2	76.2	76.2	76.2	76.2							17	
18	76.2	76.2	76.2	76.2	76.2							18	
19	76.2	76.2	76.2	76.2	76.2							19	
20	76.2	76.2	76.2	76.2	76.2	76.2						20	
22	76.2	76.2	76.2	76.2	76.2	76.2						22	
24	76.2	76.2	76.2	76.2	76.2	76.2	64.9					24	
26	76.2	76.2	76.2	76.2	76.2	76.2	76.2					26	
28	76.1	76.2	76.2	76.2	76.2	76.2	75.2	57.3				28	
30	75.5	76.2	76.2	76.2	76.2	76.2	73.2	56.2				30	
32	74.6	76.2	76.2	76.2	76.2	76.2	71.1	54.9	49.3			32	
34	72.8	76.2	76.2	76.2	76.2	76.2	69	53.6	48.4			34	
36	70.4	76.2	76.2	76.2	76.2	76	67	52.3	47.5	41.8		36	
38	67.6	75.7	76.2	76.2	76.2	74.9	65.2	51	46.6	41.3		38	
40	64	74.8	76.2	76.2	76.2	73.5	63.3	49.9	45.8	40.6	32	40	
45	53.5	71.8	76	76.2	76.2	69.5	58.7	47.5	43.6	38.8	30.9	25.4	45
50		66.8	73.8	74.4	72.6	65.8	54.7	45.1	41.3	36.9	29.8	24.5	50
55		59.9	66.1	65.4	64.2	62.7	50.8	43	39.1	35.4	28.7	23.7	55
60		50.9	58.8	58.1	57.7	58	47.4	41.1	37.1	33.9	27.8	22.9	60
65			52.4	51.7	53	51.6	44.2	39	35	32.4	26.9	22.2	65
70			47	48.4	47.6	46.2	41.4	37	33.1	30.9	26	21.4	70
75			43.1	43.7	42.9	41.6	38.8	35	31.3	29.4	25.1	20.6	75
80				39.7	38.9	37.6	36	33	29.5	27.9	24.2	19.8	80
85				36.3	35.4	34.1	32.9	31.1	27.9	26.5	23.3	19	85
90				31.6	32.4	31	31.2	29.4	26.4	25.1	22.4	18.2	90
95					29.7	28.6	28.8	27.6	25	23.8	21.5	17.3	95
100					27.3	27.2	26.4	25.7	23.7	22.6	20.6	16.5	100
105					22.5	25.5	24.2	24.2	22.5	21.5	19.7	15.6	105
110						23.6	22.3	22.3	21.1	20.4	18.8	14.8	110
115						22.3	20.6	20.6	19.4	19.3	17.9	14	115
120							19.6	19	18.4	17.9	17	13.3	120
125							18.8	17.5	17.5	16.6	16.3	12.6	125
130							17.8	16.2	16.2	15.8	15.5	12	130
135								14.9	14.9	15.1	14.4	11.4	135
140								14.2	13.8	14.3	13.3	10.8	140
145								13.7	12.7	13.2	12.3	10.3	145
150									11.9	12.3	11.4	9.9	150
155									11.3	11.5	10.6	9.4	155
160									10.9	10.8	9.9	9	160
165										10.1	9.2	8.6	165
170										9.5	8.6	8.2	170
175										8.9	8	7.8	175
180											7.5	7.4	180
185											6.9	6.9	185
190											6.5	6.4	190
195												5.9	195
200												5.5	200
205												4.9	205



LIFTING CHARTS - All Terrain Cranes

LIEBHERR MODEL LTM 1160-5.2 - 190 TON CAPACITY

Lifting capacities Forces de levage

TK

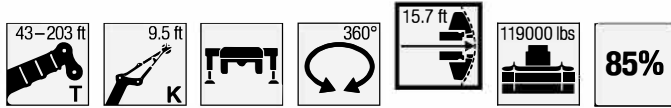

	43 ft	57 ft	72 ft	87 ft	102 ft	116 ft	131 ft	146 ft	161 ft	176 ft	191 ft	203 ft	
	9.5 ft												
10	76.2	76.2											10
11	76.2	76.2											11
12	76.2	76.2	76.2										12
13	76.2	76.2	76.2										13
14	76.2	76.2	76.2	76.2									14
15	76.2	76.2	76.2	76.2									15
16	76.2	76.2	76.2	76.2									16
17	76.2	76.2	76.2	76.2	76.2								17
18	76.2	76.2	76.2	76.2	76.2	76.2							18
19	76.2	76.2	76.2	76.2	76.2	76.2							19
20	76.2	76.2	76.2	76.2	76.2	76.2	76.2						20
22	76.2	76.2	76.2	76.2	76.2	76.2	76.2						22
24	76.2	76.2	76.2	76.2	76.2	76.2	64.9						24
26	76.2	76.2	76.2	76.2	76.2	76.2	76.2						26
28	76.1	76.2	76.2	76.2	76.2	76.2	75.2	57.3					28
30	75.5	76.2	76.2	76.2	76.2	76.2	73.2	56.2					30
32	74.6	76.2	76.2	76.2	76.2	76.2	71.1	54.9	49.3				32
34	72.8	76.2	76.2	76.2	76.2	76.2	69	53.6	48.4				34
36	70.4	76.2	76.2	76.2	76.2	76	67	52.3	47.5	41.8			36
38	67.6	75.7	76.2	76.2	76.2	74.9	65.2	51	46.6	41.3			38
40	64	74.8	76.2	76.2	76.2	73.5	63.3	49.9	45.8	40.6	32		40
45	53.5	71.8	76	76.2	75.9	69.5	58.7	47.5	43.6	38.8	30.9	25.4	45
50		66.8	71.9	71.2	70	65.8	54.7	45.1	41.3	36.9	29.8	24.5	50
55		59.9	63.2	62.5	61.3	62	50.8	43	39.1	35.4	28.7	23.7	55
60		50.9	56.1	55.4	56.5	55.3	47.4	41.1	37.1	33.9	27.8	22.9	60
65			49.9	51.3	50.5	49.1	44.2	39	35	32.4	26.9	22.2	65
70			45.4	46	45.2	43.9	41.4	37	33.1	30.9	26	21.4	70
75			41.7	41.5	40.7	39.4	38.1	35	31.3	29.4	25.1	20.6	75
80				37.7	36.9	35.5	34.3	33	29.5	27.9	24.2	19.8	80
85				34.4	33.5	32.2	32.6	31.1	27.9	26.5	23.3	19	85
90				31.3	30.6	29.9	29.7	28.6	26.4	25.1	22.4	18.2	90
95					28	28.3	27.1	26.9	25	23.8	21.5	17.3	95
100					26.2	26	24.8	24.9	23.5	22.6	20.6	16.5	100
105					22.5	24.4	22.7	22.8	21.7	21.5	19.7	15.6	105
110						22.6	21.5	20.9	20.2	19.9	18.8	14.8	110
115						21	20.3	19.2	19.1	18.2	17.9	14	115
120							19.3	17.7	17.7	17.3	17	13.3	120
125							17.9	16.3	16.3	16.6	15.8	12.6	125
130							16.6	15.6	15	15.5	14.5	12	130
135								14.7	13.8	14.3	13.3	11.4	135
140								14.2	12.8	13.2	12.3	10.8	140
145								13.6	12.2	12.2	11.4	10.3	145
150									11.7	11.4	10.6	9.9	150
155									11.2	10.7	9.8	9.4	155
160									10.6	10	9.1	9	160
165										9.3	8.4	8.4	165
170										8.7	7.8	7.8	170
175										8.1	7.3	7.2	175
180											6.7	6.7	180
185											6.2	6.2	185
190											5.8	5.7	190
195												5.3	195
200												4.8	200
205												4.5	205



LIFTING CHARTS - All Terrain Cranes

LIEBHERR MODEL LTM 1160-5.2 - 190 TON CAPACITY

Lifting heights Hauteurs de levage

TK

